



无锡市东舟船舶设备股份有限公司

WUXI DONGZHOU MARINE EQUIPMENT CO.,LTD.

无锡市东舟船舶工程有限公司

WUXI DONGZHOU ENGINEERING CO.,LTD.

地址：江苏省无锡市锡山区东北塘镇农石路 22 号 (214191)

No.22 Nongshi Road,Dongbeitang Town, Wuxi City, Jiangsu Province

E-mail: wuxidongzhou@chuanpo.com Website: www.chuanpo.com

Tel: 0510-83778700 83775873 (总机) 0510-8377298 (经营部)

Fax: 0510-83771228

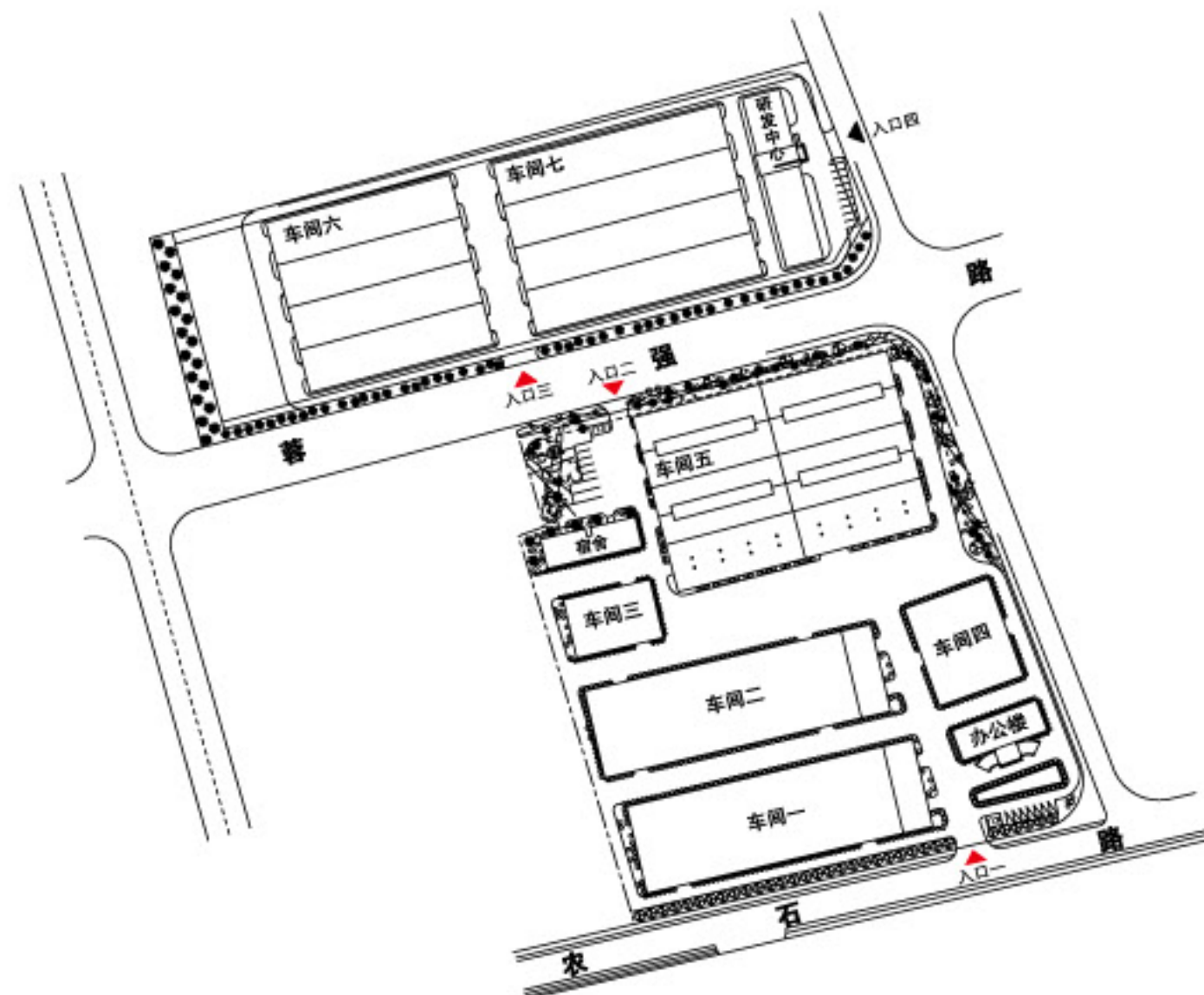

839012

Marine
DONGZHOU

内装·家具系列

FURNITURE AND INTERIOR DECORATION



www.chuanpo.com

无锡市东舟船舶设备股份有限公司

WUXI DONGZHOU MARINE EQUIPMENT CO.,LTD.

无锡市东舟船舶工程有限公司

WUXI DONGZHOU ENGINEERING CO.,LTD.



企业简介

Company Introduction

无锡市东舟船舶工程有限公司，是由原无锡市东舟船舶设备股份有限公司的全资子公司，总公司于1998年首次通过了CCS的ISO9001质量体系认证和ISO14001:2004环境管理体系认证；2008年至今被认定为江苏省高新技术企业，2010年被认定为江苏省创新型企业；2015年被评为省科技民营企业，取得省著名商标称号，多年来被评为AAA信用等级企业，2017年获得保密及新时代质量体系认证。东舟工程分公司隶属于东舟股份公司管控，在运行机制及管理模式上，分享着总公司长期运行所积累的红利，且更加灵便与卓越。工程公司从总公司各部门挑选优秀员工达90余人，占地面积3万多平方米，注册资本2000多万元。

公司主要生产与经营各种材料的船用家具、金属箱柜、铝蜂窝板及复合岩棉板、内装工程的设计与安装等等。我司已拥有一批多年从事内装行业的资深级员工，主导参与过3000吨海警船、1000吨海警船、600吨海巡船、观光旅游船、豪华客滚船、远洋捕鱼船等200多艘船的家俱与内装的设计及施工任务，深受客户的好评。

公司依靠科技与智慧的力量不断开拓市场，本着质量求严、技术求精、经营求信的理念，开启船用家具及内装工程的新篇章。

Wuxi Dongzhou Marine Engineering Co., LTD., is a wholly-owned subsidiary from original Wuxi Dongzhou Marine Equipment Co., LTD. The company has passed the ISO9001 quality system certification and ISO14001:2004 environmental management system certification in 1998, which has been recognized as a high-tech enterprise in Jiangsu province since 2008, and was recognized as Jiangsu province innovative enterprise in 2010. It was awarded as the provincial science and technology private enterprise, and won the title of provincial famous trademark in 2015, and was awarded AAA credit rating enterprise for many years. We obtained the certification of confidentiality and new Era quality system in 2017. Dongzhou Engineering Branch is under the control of Dongzhou Joint-stock Company. In terms of operation mechanism and management mode, it shares the dividends accumulated by the long-term operation of the parent company, and is more flexible and excellent. The engineering company selects more than 90 outstanding employees from various departments of the head office, covering an area of more than 30,000 square meters, with a registered capital of more than 20 million yuan.

The company mainly produces and manages Marine furniture of various materials, metal cabinets, aluminum honeycomb panels and composite rock wool panels, the design and installation of inner installation projects and so on. Our company has a group of senior expert-level staff engaged in the interior decoration industry for many years, leading to participate in the design and construction of furniture and interior decoration for more than 200 vessels such as 3000 tons of coast guard ships, 1000 tons of coast guard ships, 600 tons of sea patrol ships, sightseeing boats, luxury passenger rolling boats, ocean fishing boats, and so on, which are well received by customers.

The company relies on the power of science and technology and wisdom to expand the market, with the concept of strict quality, technical refinement, management and credibility, opened a new chapter of Marine furniture and interior decoration engineering.

家具生产设备

Furniture Production Equipment



开料机
Cutting Machine



剪板机
Shearing Machine



冷压机
Cold Press Machine



封边机
Edge Banding Machine

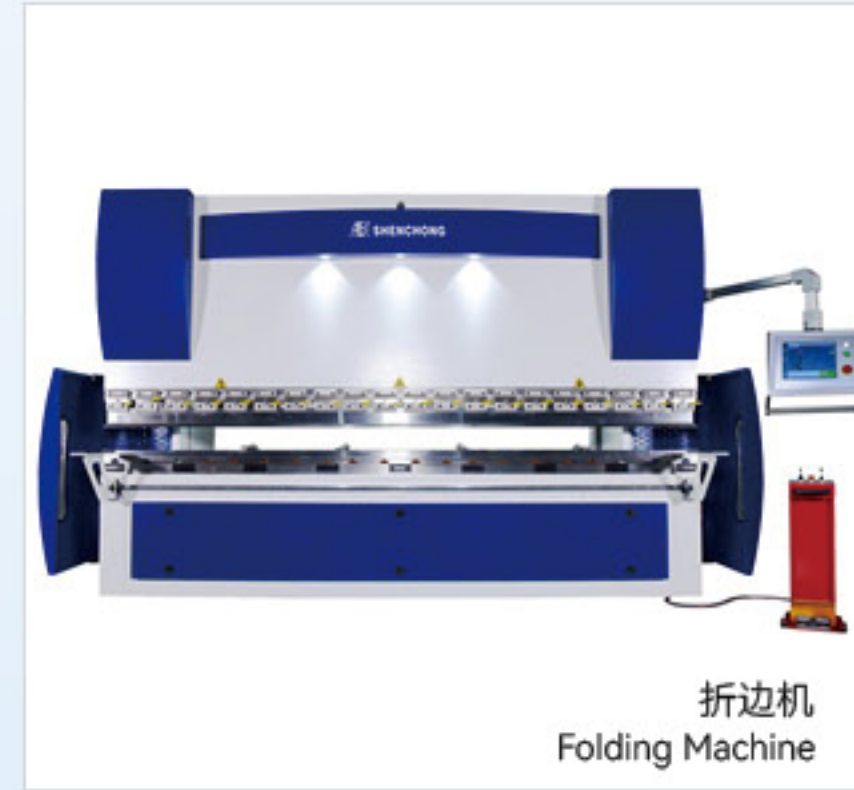

折边机
Folding Machine



侧面钻
Side-Hole Boring Machine



推台机
Sliding Table Saw



全自动 PUR 全铝家具专机
Automatic PUR All Aluminum Home

技术团队

Technical Team





目录 Catalogue

船用铝蜂窝家具 Marine Aluminum Honeycomb Furniture	6
船用全铝家具 Marine All Aluminum Furniture	7
船用金属家具 Marine Metal Furniture	10
船用金属柜 Marine Metal Tank	11
船用木质家具 Marine Wooden Furniture	12
船用翻床 Marine Trunover Bed	15
玻璃隔断 Glazed Wall	16
整体式阳台 Integral Balcony	17
不锈钢护栏 Stainless Steel Guard Bar	18
冷库及气调保鲜 Cold Storage And Air Conditioning Preservation	19
复合岩棉板 (铝蜂窝板) Composite Rock Wool Board (Aluminum Honeycomb Board)	22
内装工程 Interior Decoration Engineering	26
小五金 Hardware	28
船用椅子 Marine Chair	30
色卡 Color Card	31

船用铝蜂窝家具

Marine Aluminum Honeycomb Furniture

铝蜂窝家具是由耐高温防火板、铝板、铝蜂窝等材料用特种胶水采用特殊工艺压制而成的复合板材，经过封边修饰，再通过优质五金件拼装成形。在保证产品外观、气质高雅、结构牢固的同时，减轻了产品重量，同时还具有防火、抗压、需耐磨、防褪色、可手拆式组装等特点，是一种新型的船舶舱室家具，符合船舶现代家具发展需要。



铝蜂窝板剖面
Sectional Drawing

Aluminum honeycomb furniture is composed of high temperature fireproof board, aluminum board, aluminum honeycomb and other materials with special glue and special technology pressed into the composite plate, after edge sealing modification, and then assembled by high-quality hardware. In order to ensure the appearance of the product, elegant temperament, firm structure, reduce the weight of the product, at the same time, it also has fire, pressure resistance, wear-resisting, anti-fading, hand disassembly and other characteristics, it is a new ship cabin furniture, meet the development needs of modern ship furniture.



写字台
Desk



床头柜
Bed Side Capboard



单人床
Single Bed



双门衣柜
Closet



船用全铝家具

Marine All Aluminum Furniture

全铝家具是“防水、防火、耐腐蚀、防虫蛀、零甲醛、零污染”的绿色环保家具。铝合金家具在结构外包覆实木皮、PVC膜及表面转印处理，产品外观同实木完全一样。它有实木纹理感观效果、亲和力强、品质高端、外观奢华，是高档船舶家具的选择。同时重量更轻，比实木家具可以降低30%左右。

All aluminum furniture is "waterproof, fireproof, anti-corrosion, moth-proof, zero formaldehyde, zero pollution" of green furniture. Aluminum alloy furniture is coated with solid wood veneer, PVC film and surface transfer processing, the product appearance is exactly the same as solid wood. It has solid wood texture effect, strong affinity, high-end quality, luxury appearance, is the choice of high-grade ship furniture. At the same time lighter weight, than solid wood furniture can be reduced by about 30%.

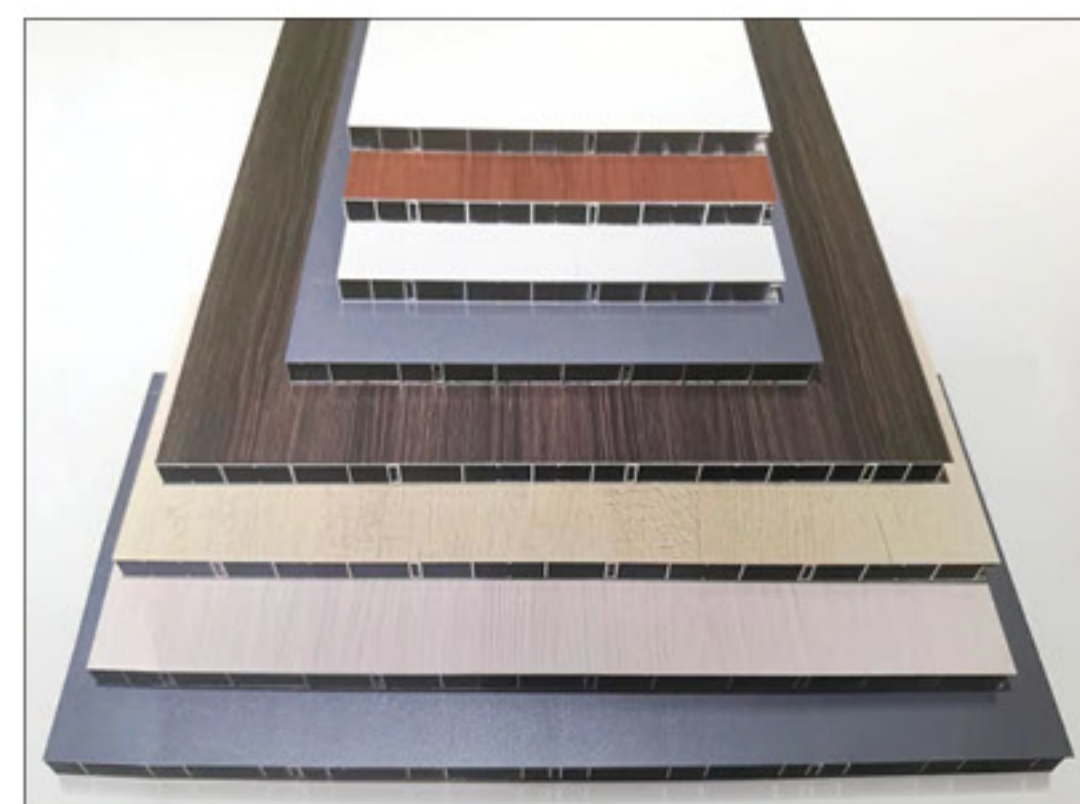

全铝焊接整板
All Aluminum Welded Whole Board



组合柜
All Aluminum Combined Cabinet



全铝家具
Marine All Aluminum Furniture

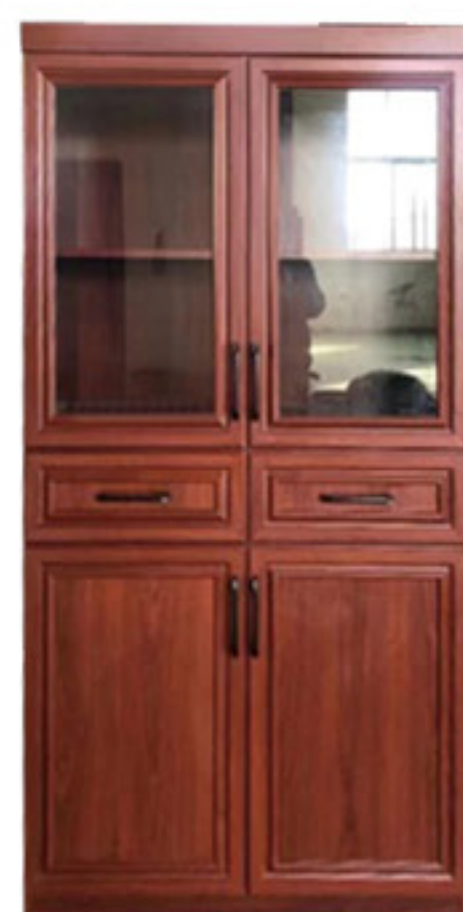

资料柜
All Aluminum File Cabinet



仿古茶几
All Aluminum Antique Tea Table



全铝组合柜
All Aluminum Combined Cabinet



船用全铝家具

Marine All Aluminum Furniture

全铝家具型材 Marine All Aluminum Furniture Profile

	DZJ-002 20 85 10.3 壁厚: 0.8mm 米重: 0.55Kg/m		DZJ-003 20 58 10.3 壁厚: 0.8mm 米重: 0.39Kg/m
	DZJ-029 20 58 10.3 壁厚: 0.8mm 米重: 0.38Kg/m		DZJ-029T 18.3 58 20 壁厚: 0.9mm 米重: 0.37Kg/m
	DZJ-030 20 60 5.3 壁厚: 0.8mm 米重: 0.37Kg/m		DZJ-030A 47 5.3 20 壁厚: 0.8mm 米重: 0.29Kg/m
	DZJ-031 18 41 5.3 壁厚: 0.8mm 米重: 0.29Kg/m		DZJ-032 20 51 5.3 10.3 壁厚: 0.7mm 米重: 0.38Kg/m
	DZJ-032A 4.9 51 20 壁厚: 0.9mm 米重: 0.38Kg/m		DZJ-009 10 104 壁厚: 0.55mm 米重: 0.37Kg/m
	DZJ-009A 100 10 壁厚: 0.55mm 米重: 0.38Kg/m		DZJ-010A 103 10 壁厚: 0.55mm 米重: 0.38Kg/m

全铝家具型材断面的更多款式请与东舟公司的经营及技术咨询。



船用全铝家具

Marine All Aluminum Furniture

全铝家具型材 Marine All Aluminum Furniture Profile

	DZJ-005 18 100 壁厚: 0.7mm 米重: 0.48Kg/m		DZJ-006 18 50 壁厚: 0.8mm 米重: 0.3Kg/m
	DZJ-007 18 100 壁厚: 0.8mm 米重: 0.58Kg/m		DZJ-014A 50 50 壁厚: 0.8mm 米重: 0.46Kg/m
	DZJ-015A 50 100 壁厚: 1mm 米重: 0.95Kg/m		DZJ-016 48 80 壁厚: 0.9mm 米重: 0.79Kg/m
	DZJ-016D 81.6 62.4 1.64 壁厚: 0.9mm 米重: 0.6Kg/m		DZJ-011C 46 24 壁厚: 0.6mm 米重: 0.19Kg/m
	DZJ-011 51 34 壁厚: 1mm 米重: 0.86Kg/m		DZJ-011A 36 35 壁厚: 0.8mm 米重: 0.34Kg/m
	DZJ-011B 48 56 壁厚: 0.7mm 米重: 0.45Kg/m		DZJ-013 50 28 壁厚: 0.8mm 米重: 0.35Kg/m

上面为部份全铝家具型材断面, 更多的型材断面可咨询本公司营销人员。



船用金属家具

Marine Metal Furniture

产品满足船用钢质床 GB/T1559-1984、船用金属桌 CB551-1981 等标准, 可为用户制作特殊要求的非标产品, 材料可为不锈钢、铝、优质碳素钢等。

The products meet the standards of Marine steel bed GB/T1559-1984, Marine metal table CB551-1981, etc., and we can produce non-standard products with special requirements for users. The materials can be stainless steel, aluminum, high quality carbon steel, etc.

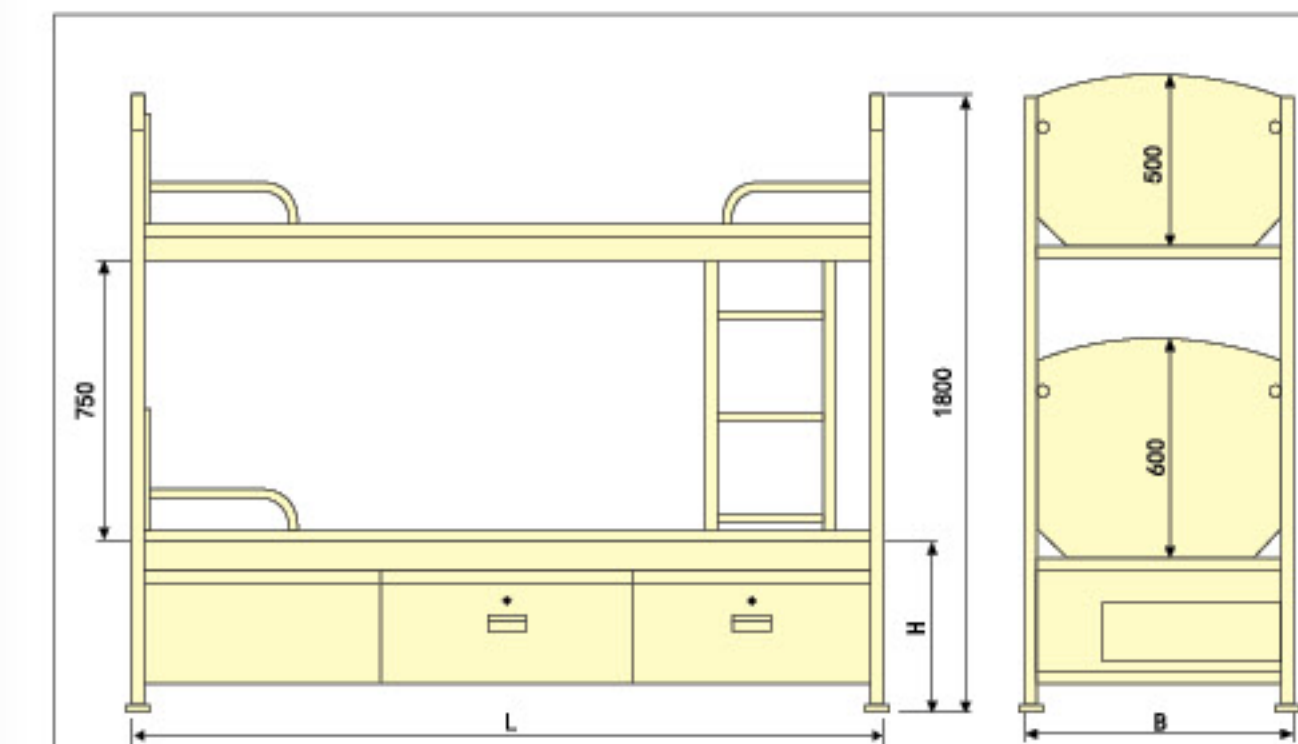

双层柜床
Bunk Bed With Drainers

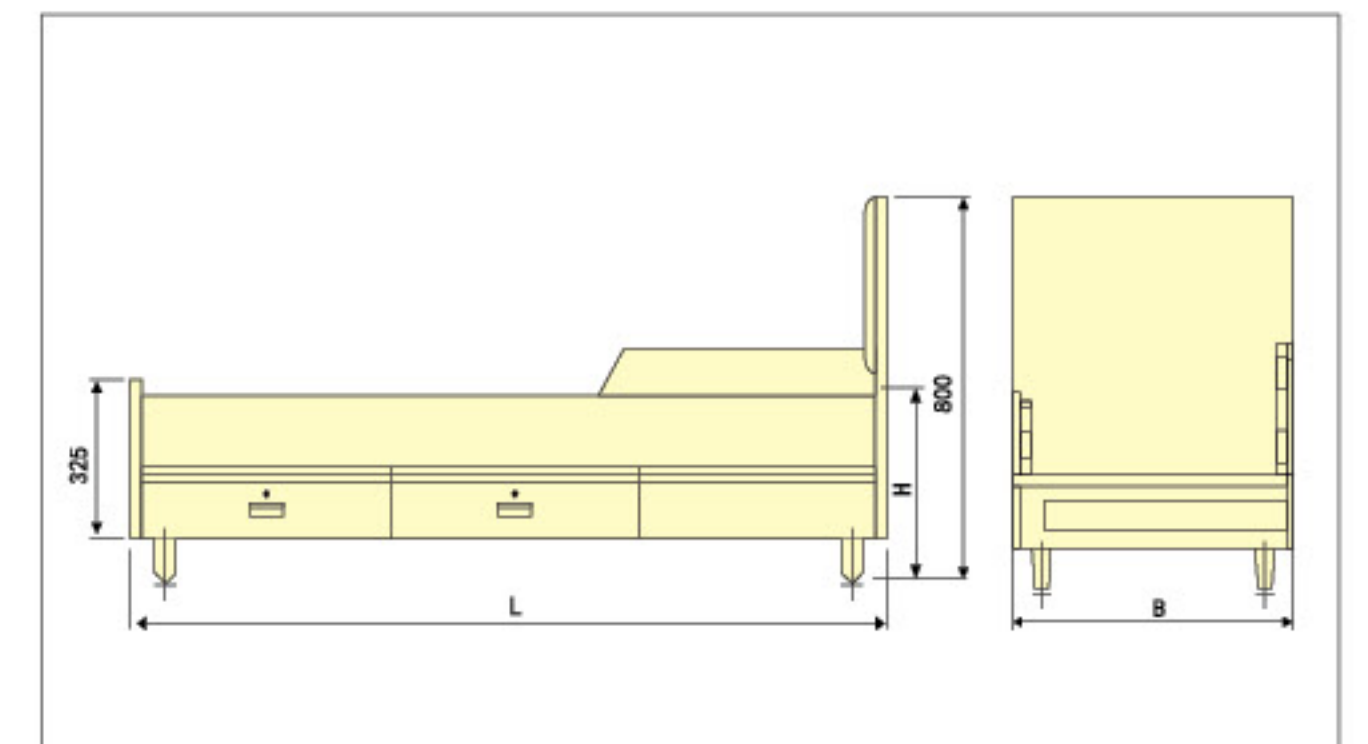

单人软垫柜床
Single Soft Cushion Bed

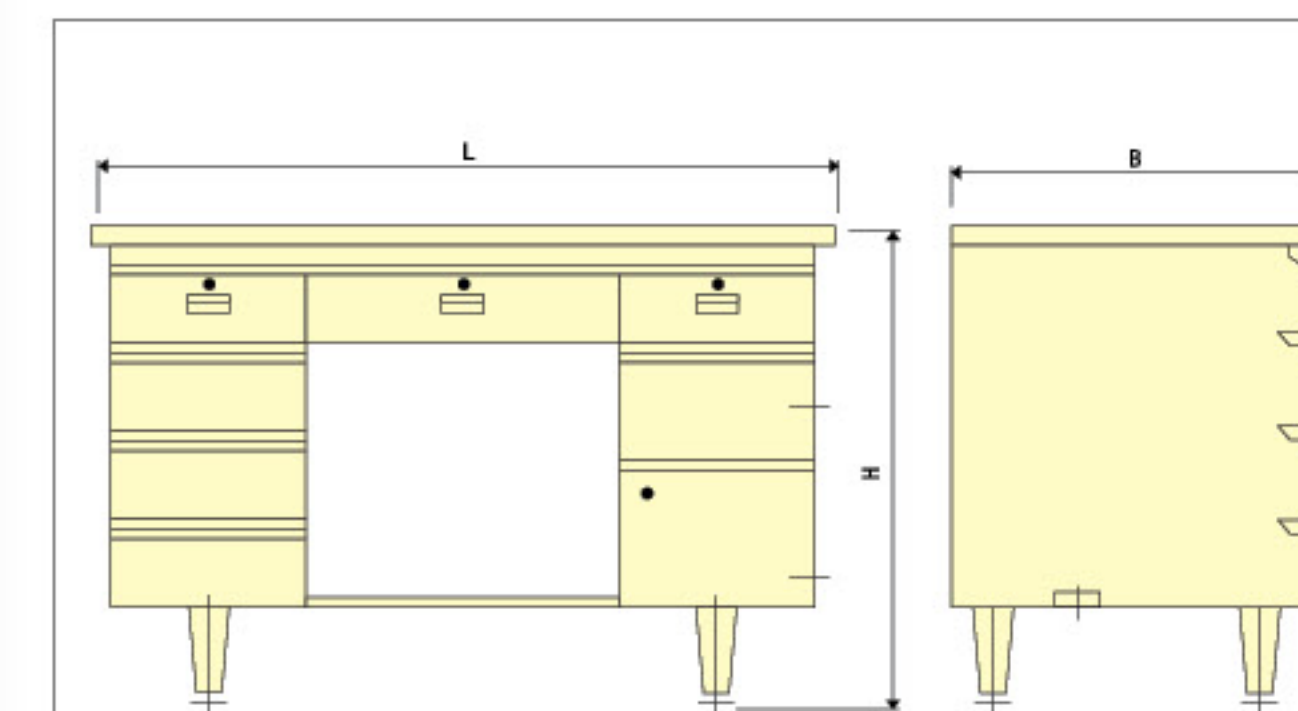

双台座办公桌
Double Dado Desk

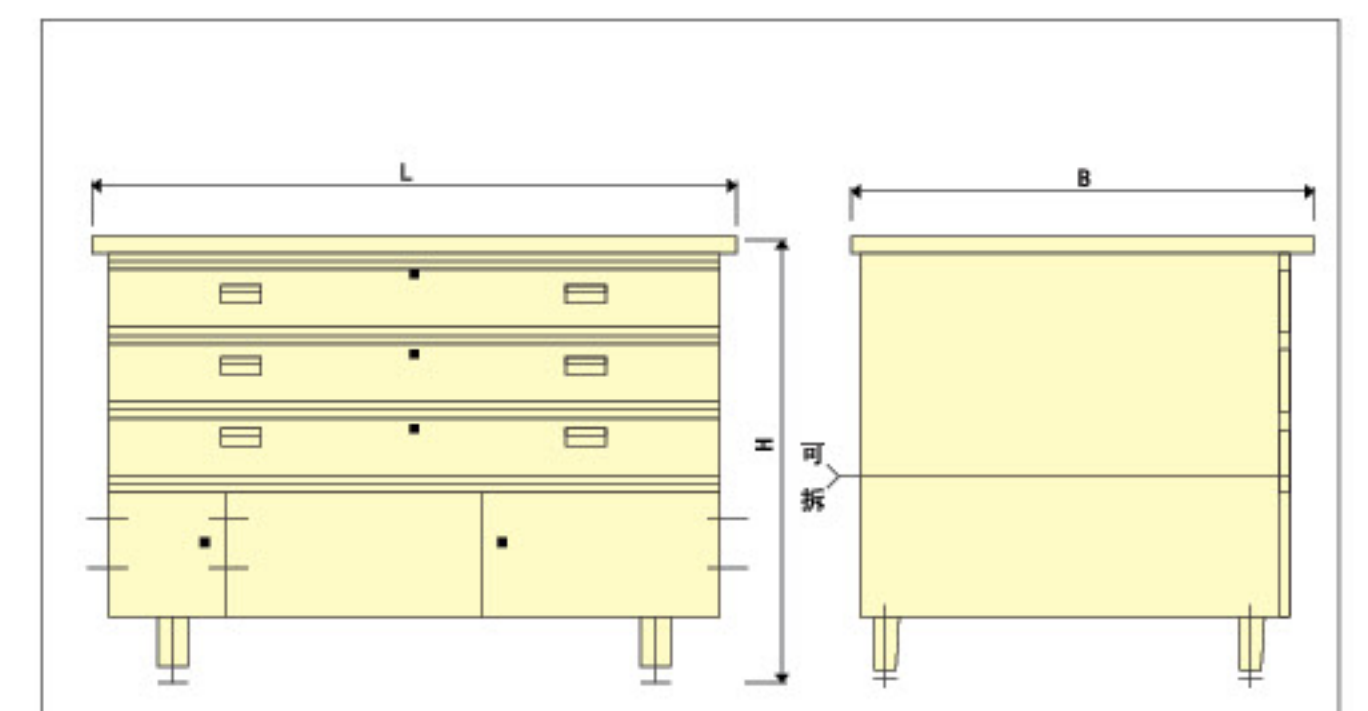

海图桌
Chart Desk

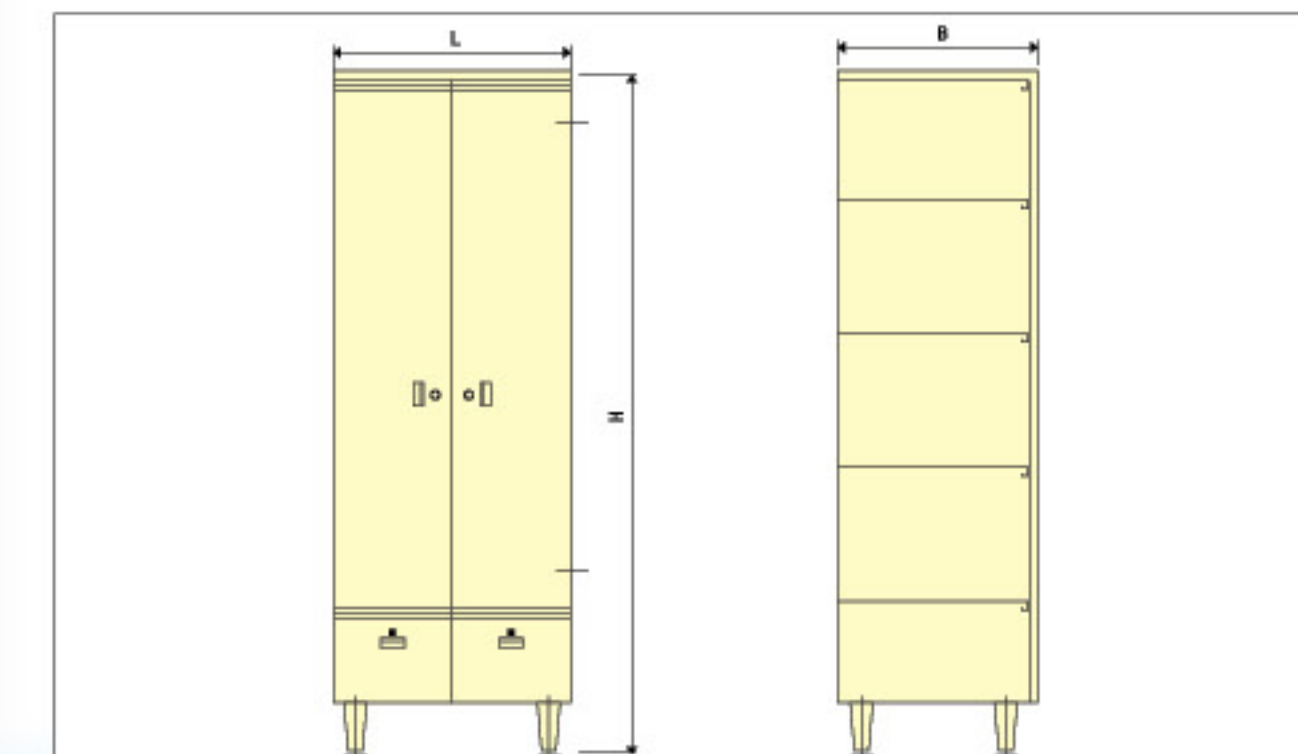

衣物柜
Clothings Cabinet

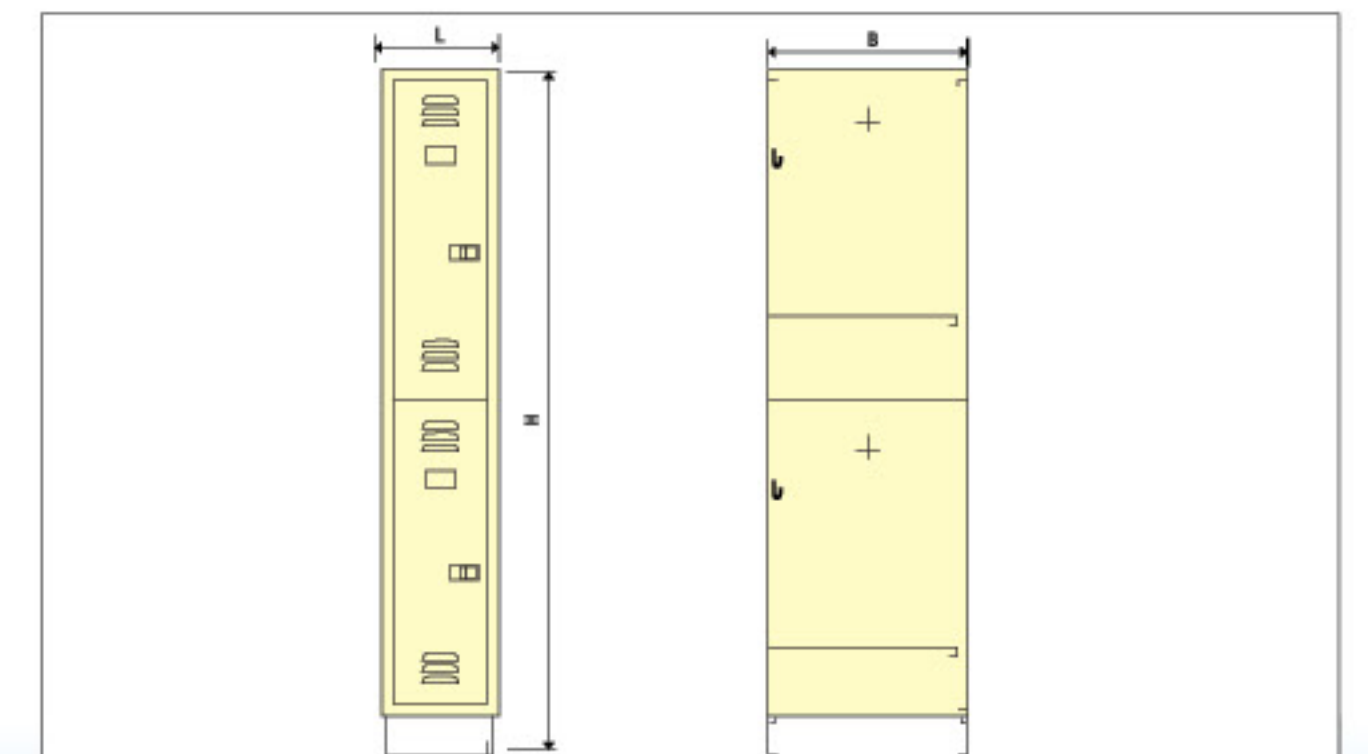

更衣柜
Clothings Cabinet



船用金属柜

Marine Metal Tank

满足 CB552-1981 标准, 可为用户制作特殊要求的床头柜、衣柜、文件柜等非标产品, 材料可为不锈钢、铝、优质碳素钢等。

According to CB552-1981 standard, we can produce non-standard products such as bedside cabinets, wardrobes and file cabinets with special requirements. The materials can be stainless steel, aluminum, high quality carbon steel, etc.

型号	名称	基本尺寸 mm			结构材质	重量 KG		
		L	B	H				
A45*50*55	床头柜	450	500	550	钢	12		
A55*50*65		550		650	铝	8		
B45*55		单门衣柜		450	550	1800	钢	30
B50*55				500		1900	铝	25
			2000	钢		31		
					铝	26.5		
C85*55	双门衣柜	850	550	1800	钢	40		
C100*55		1000		1900	铝	35		
				2000	钢	45		
						铝	30.5	
E45*65*110	文件柜	450	650	1100	钢	45		
E45*65*140				1400	铝	30.5		
						钢	50.5	
					铝	42.5		

单门衣柜 Single Closet

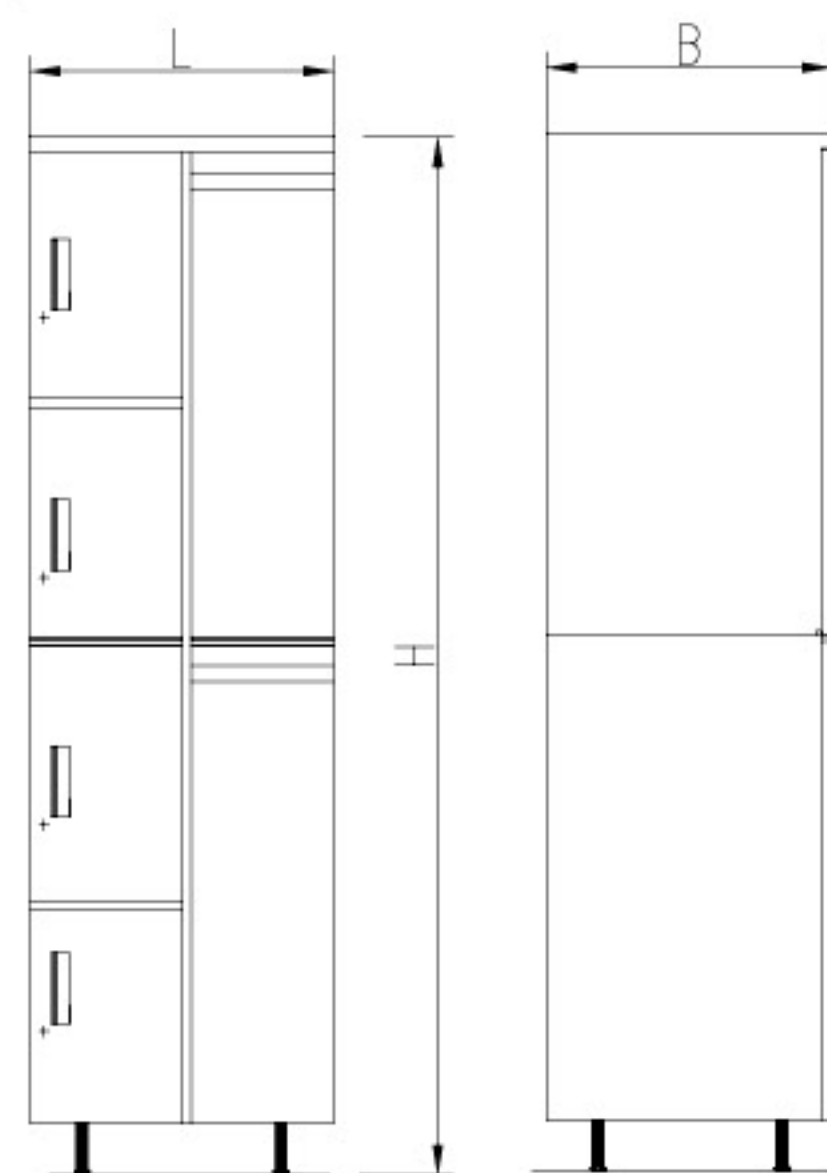

床头柜 Bedside Cupboard

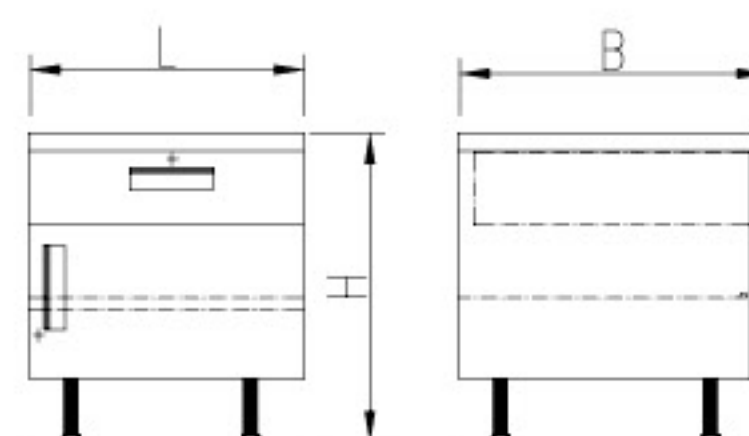

双门衣柜 Double Closet

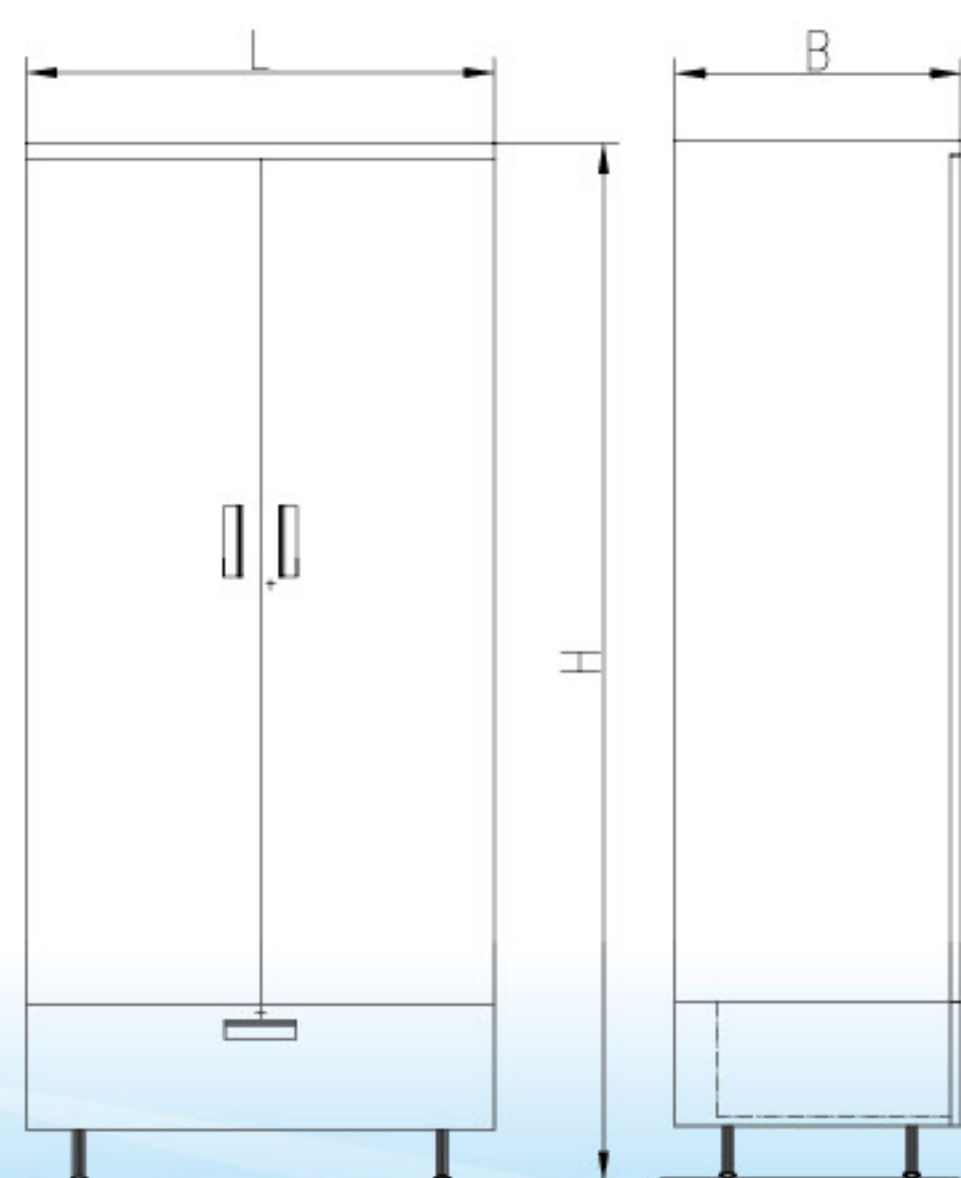

文件柜 File Cabinet

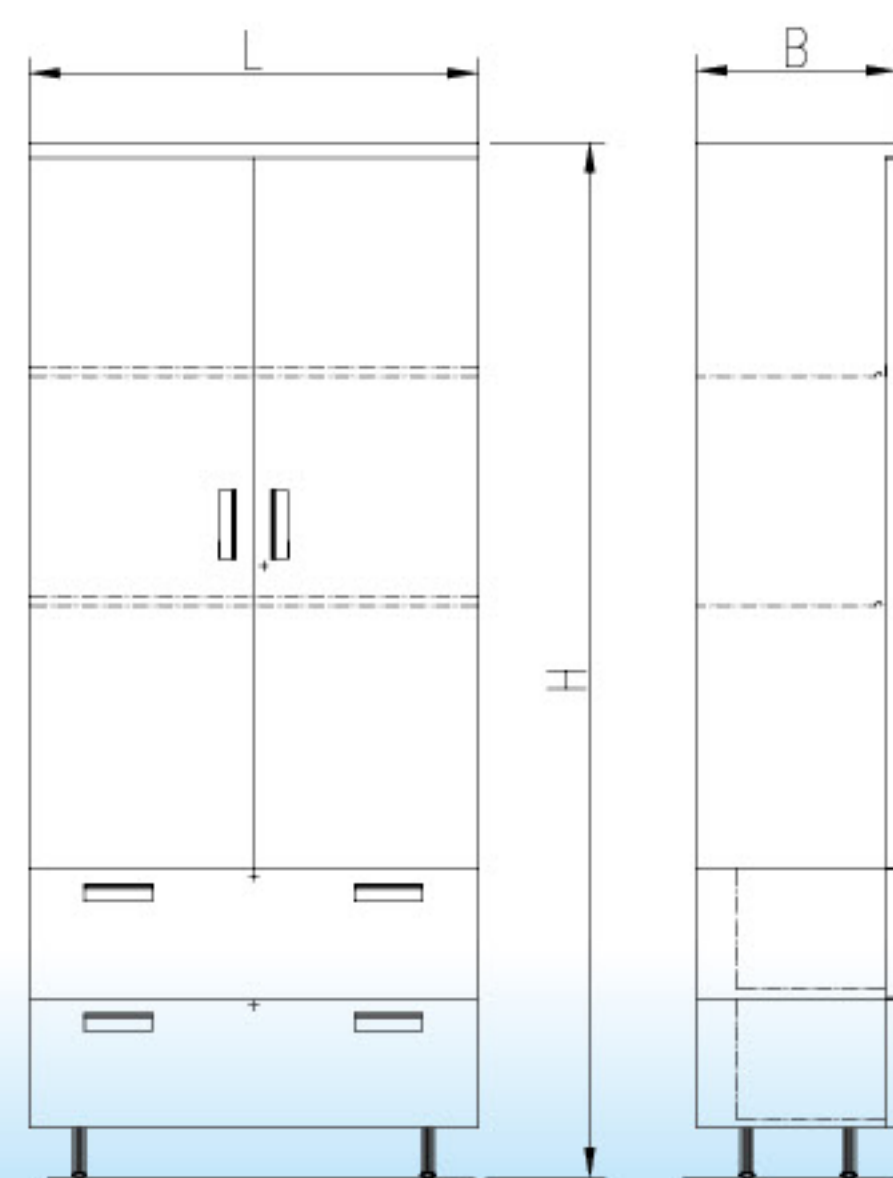

船用木质家具

Marine Wooden Furniture

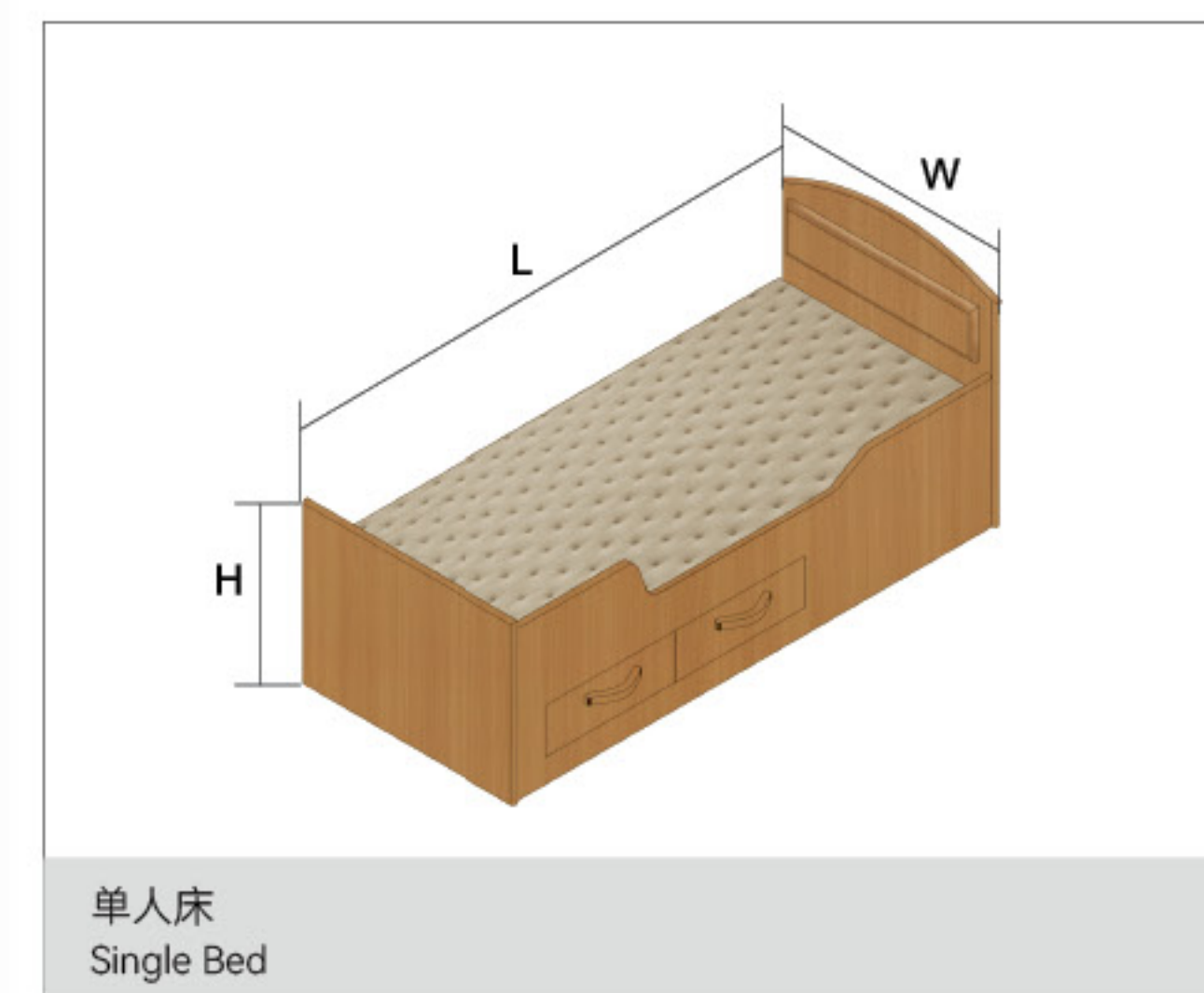

单人床
Single Bed

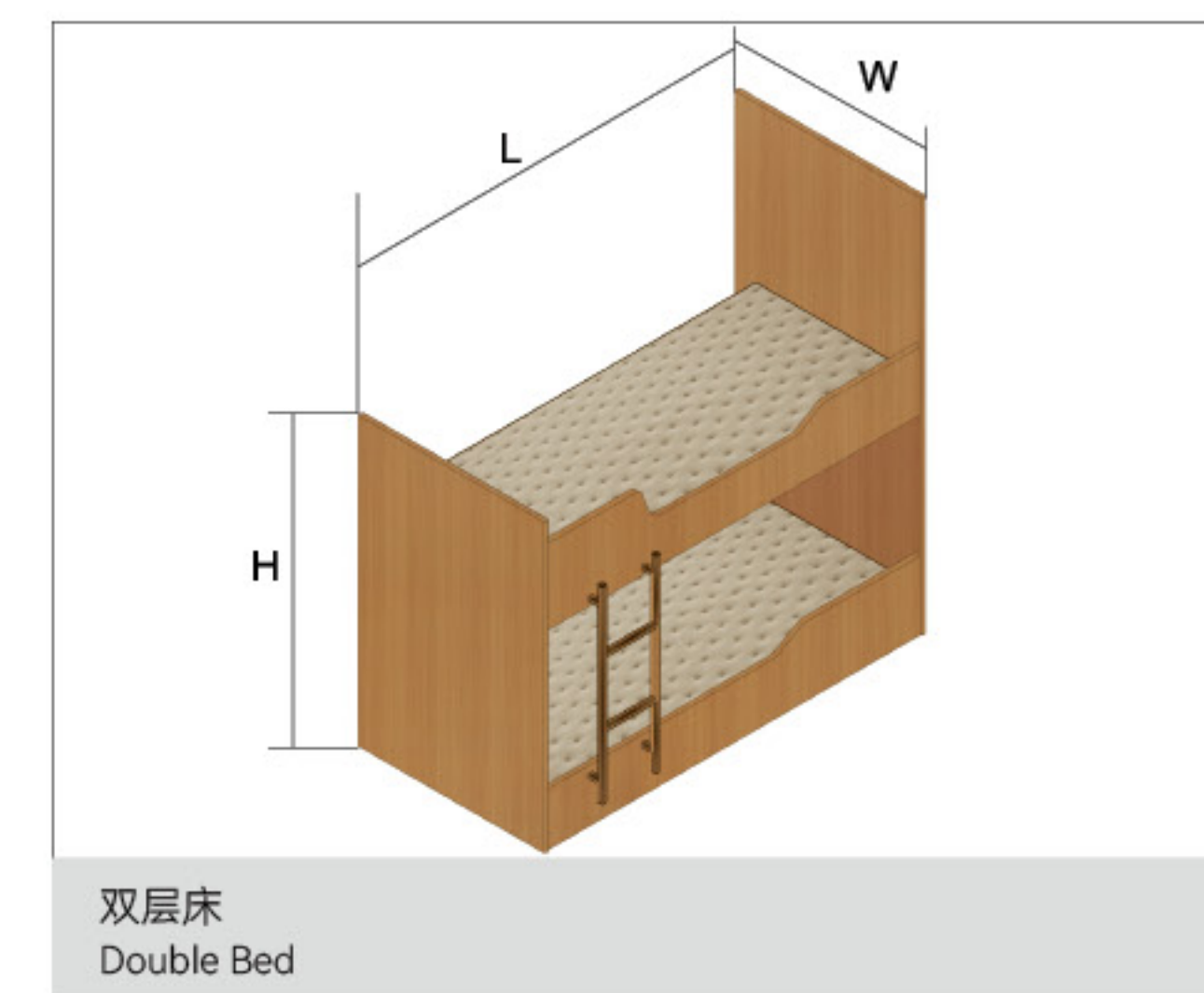

双层床
Double Bed

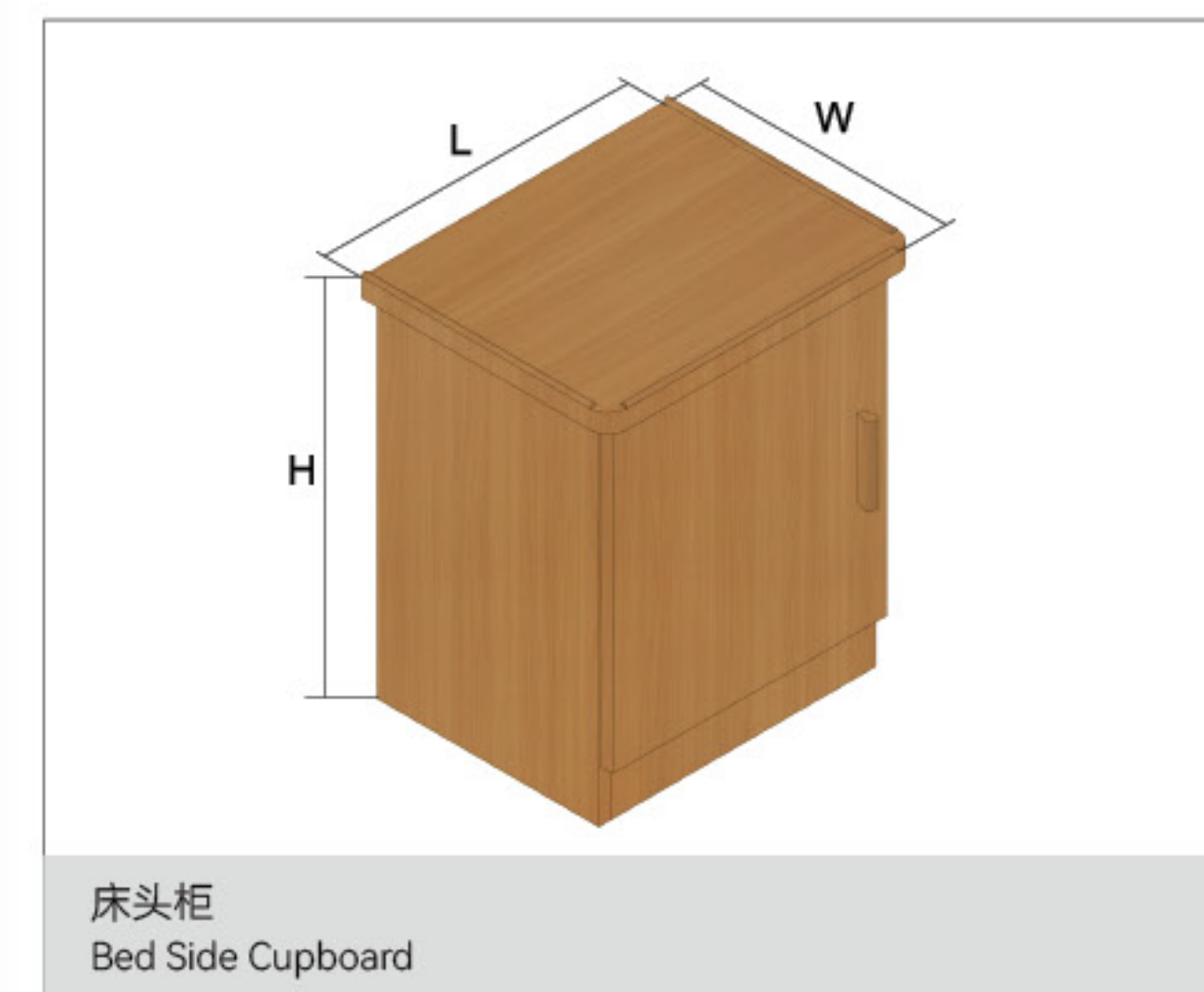

床头柜
Bed Side Cupboard

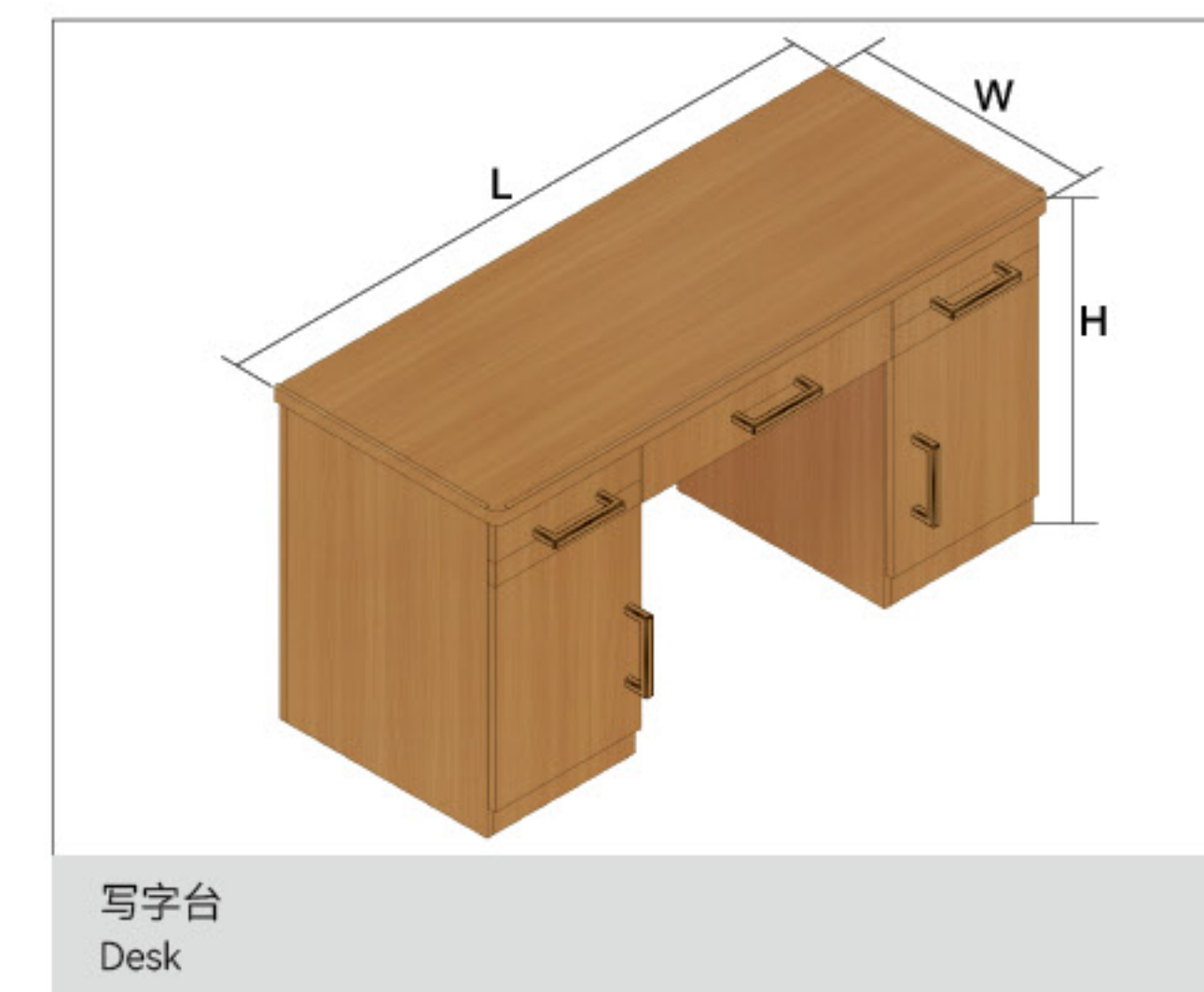

写字台
Desk

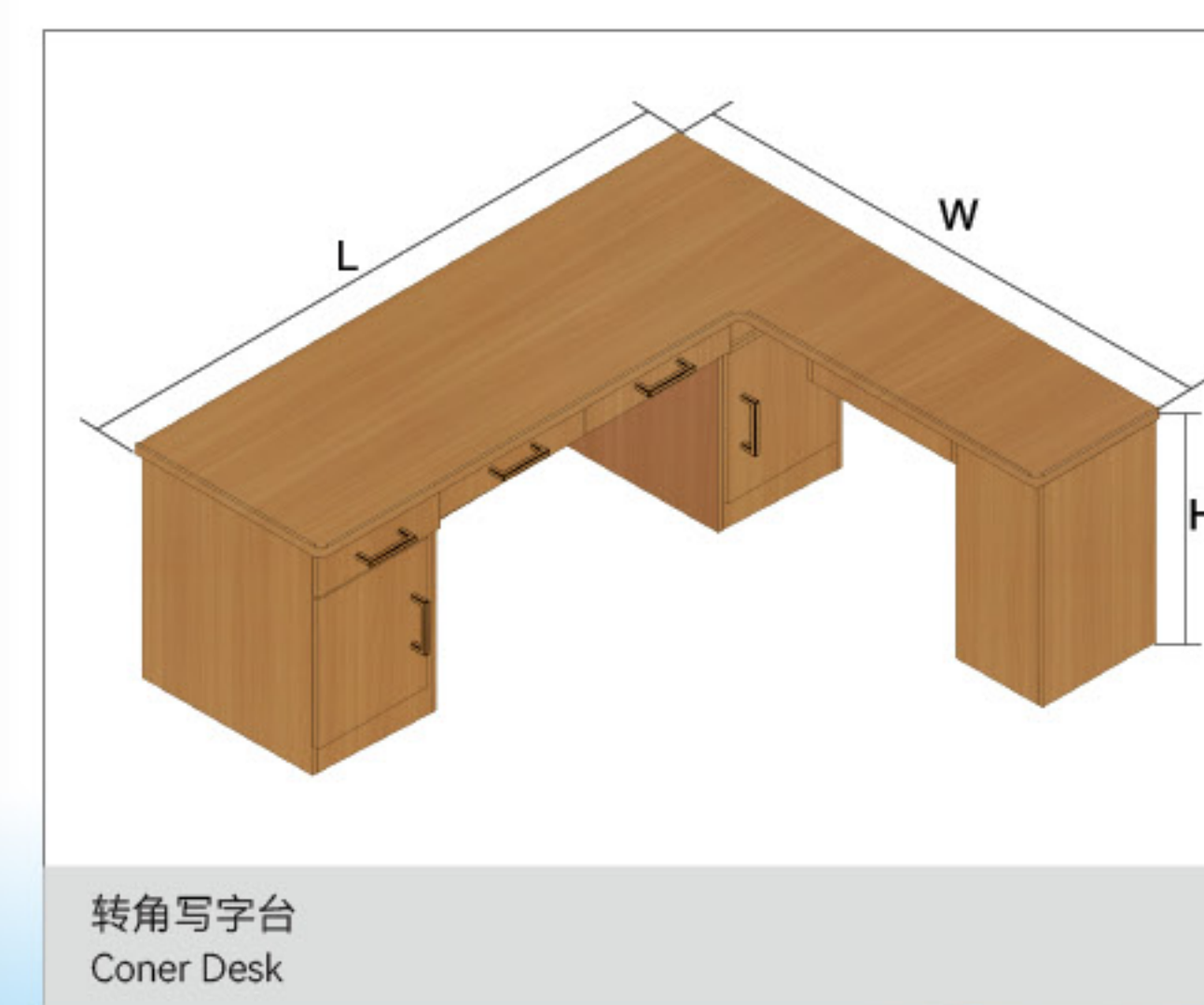

转角写字台
Coner Desk

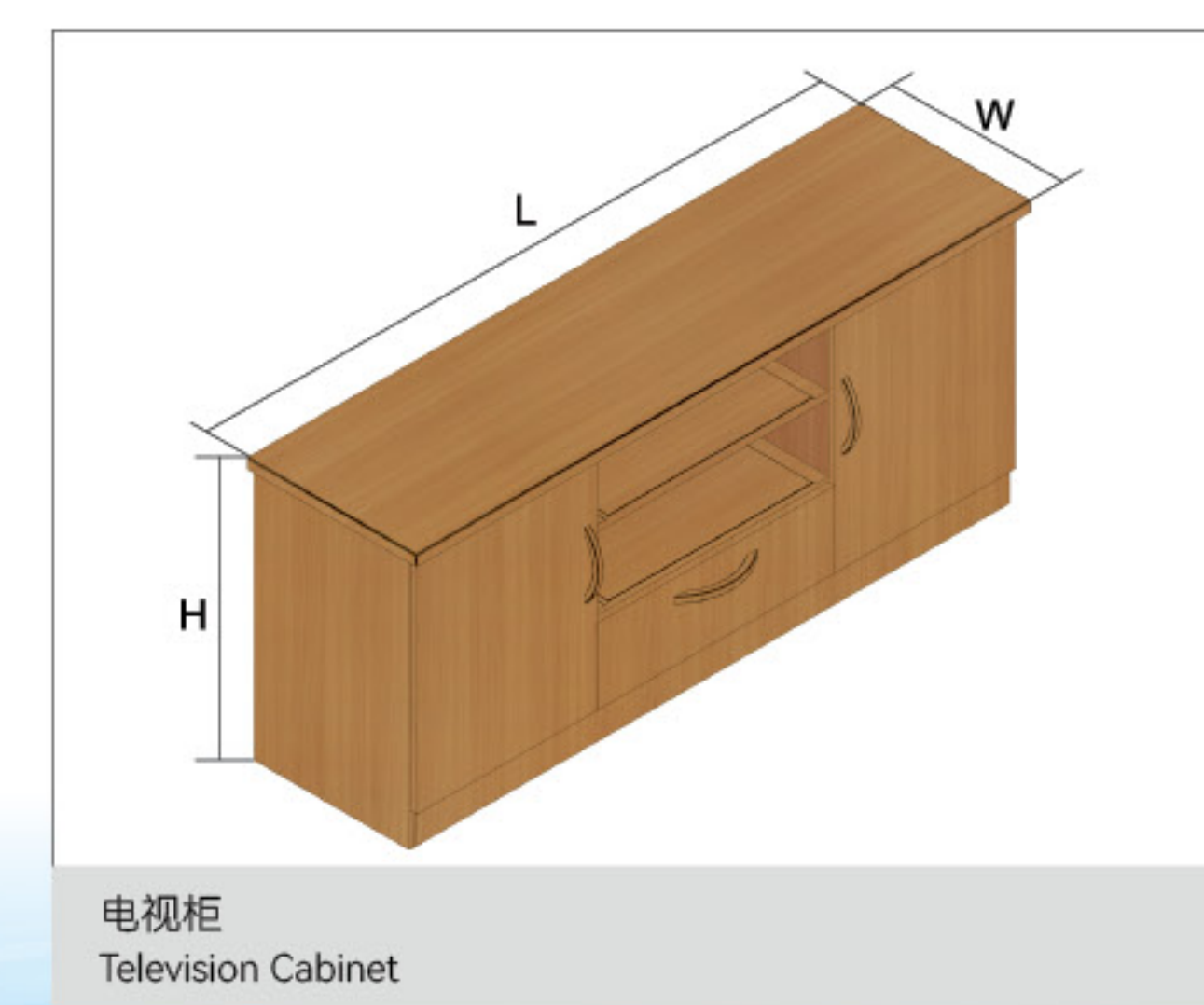

电视柜
Television Cabinet

船用木质家具

Marine Wooden Furniture

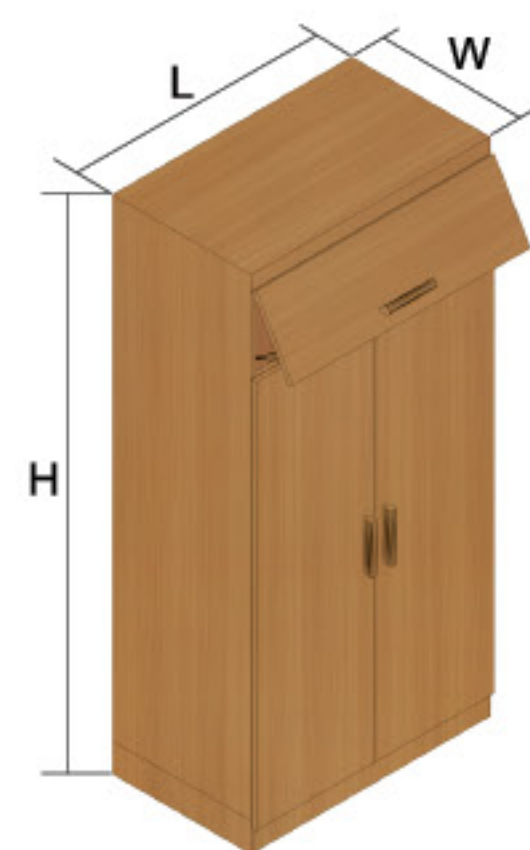

单人双门衣柜
Single Closet

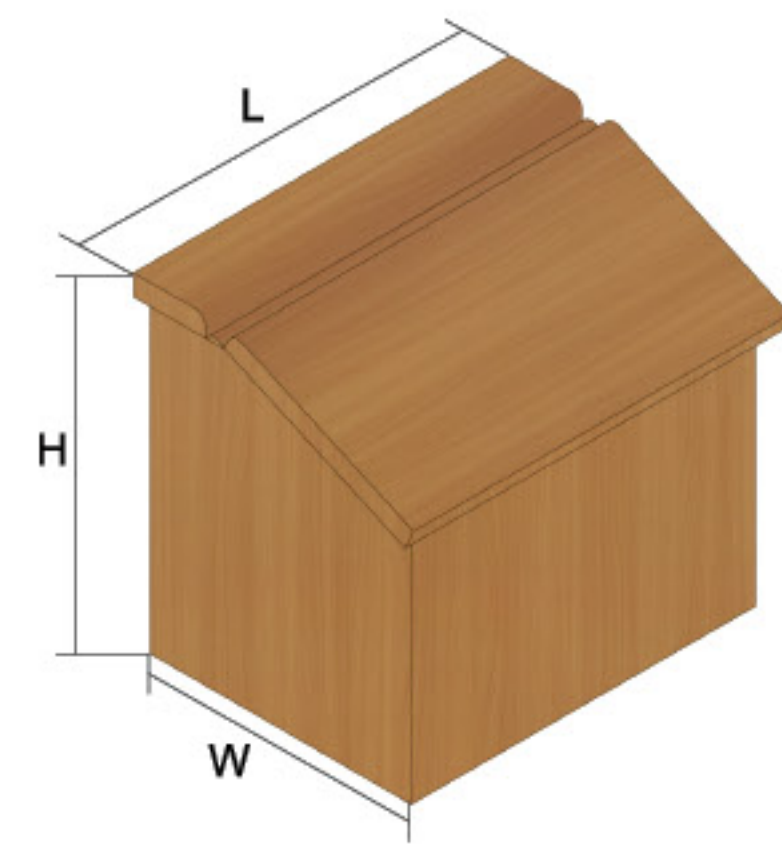

望远镜箱
Binocular Case

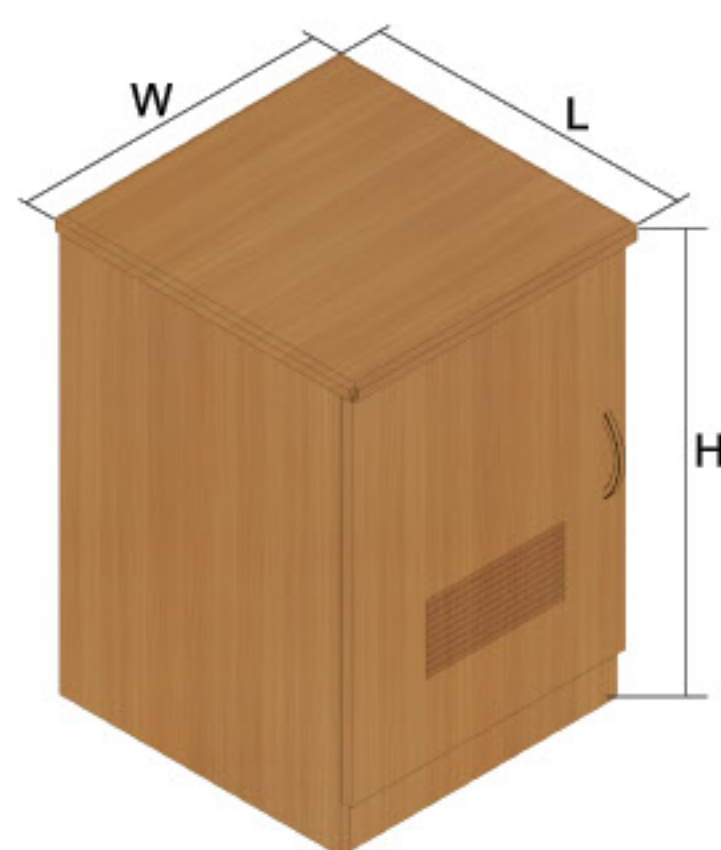

冰箱柜
Refrigerator Closet

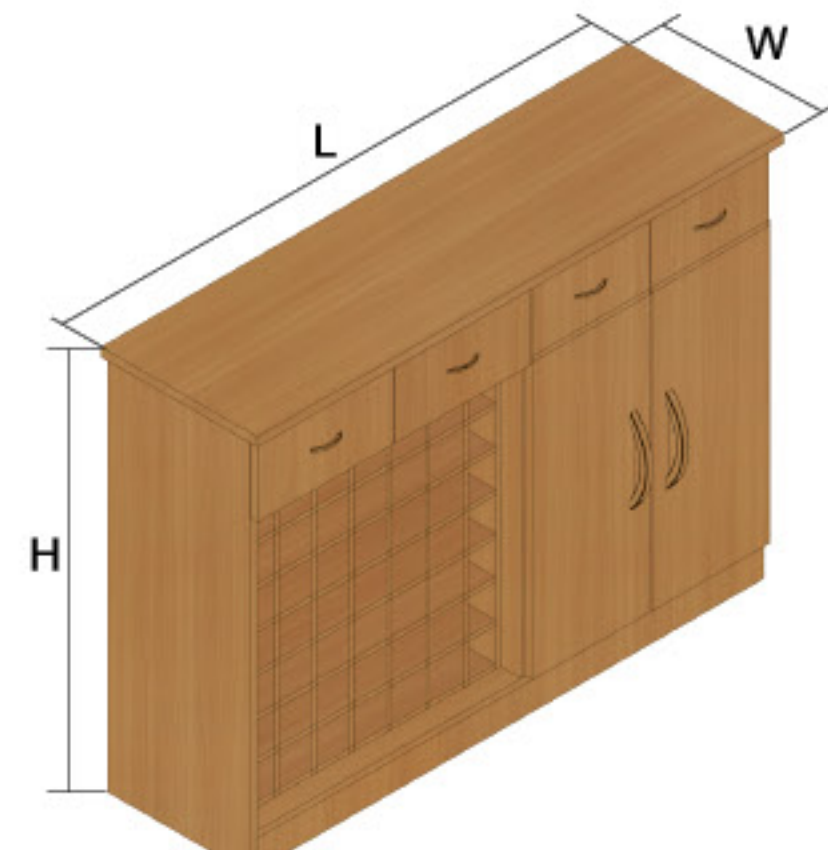

旗箱
Flag Lovker

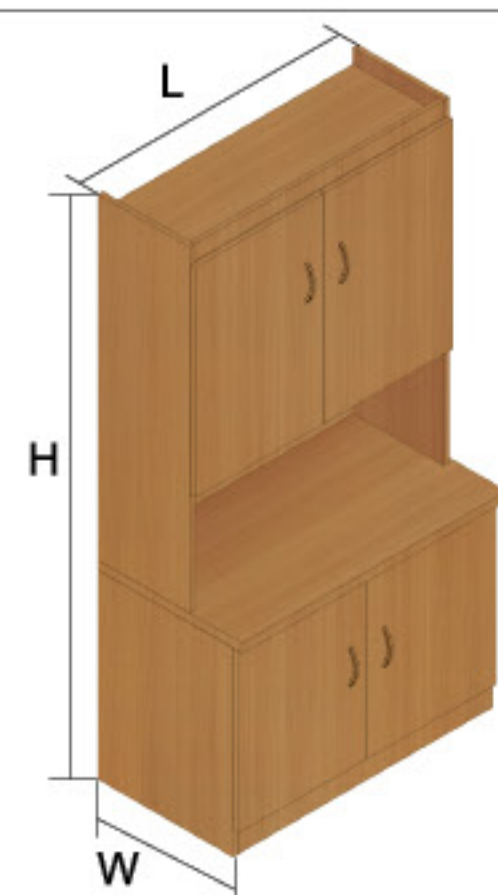

药柜
Medicine Cabinet

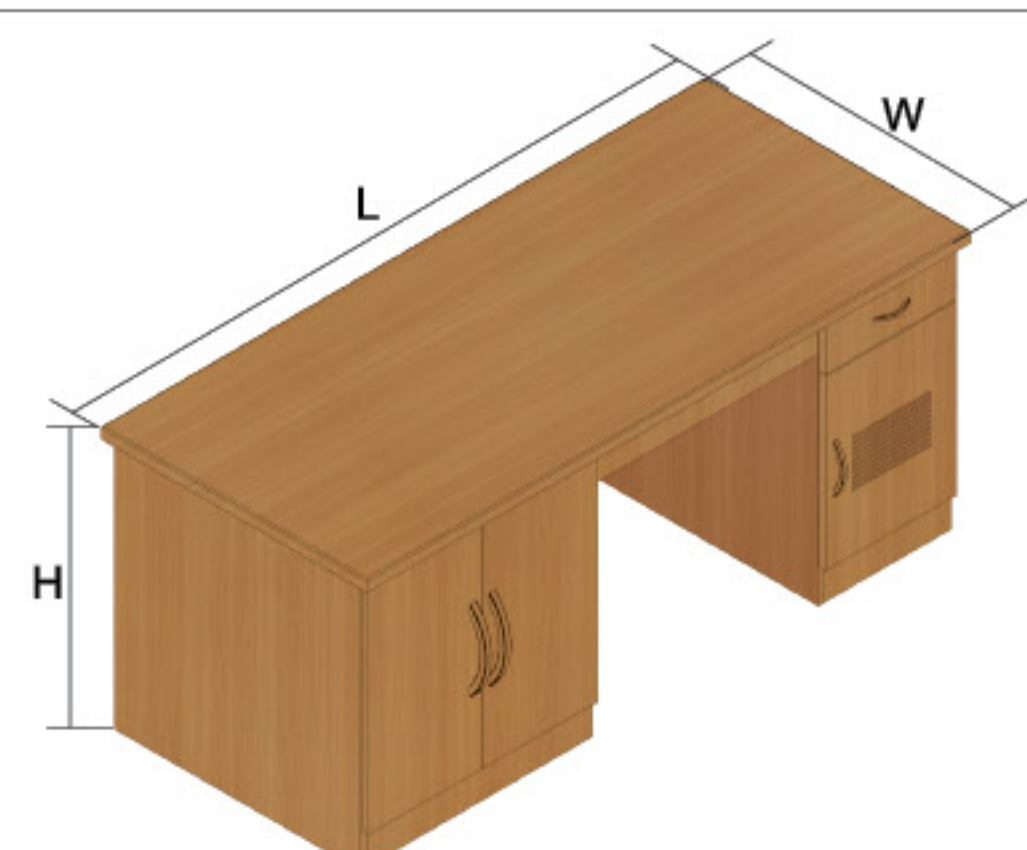

报务桌
Telegraphic Table

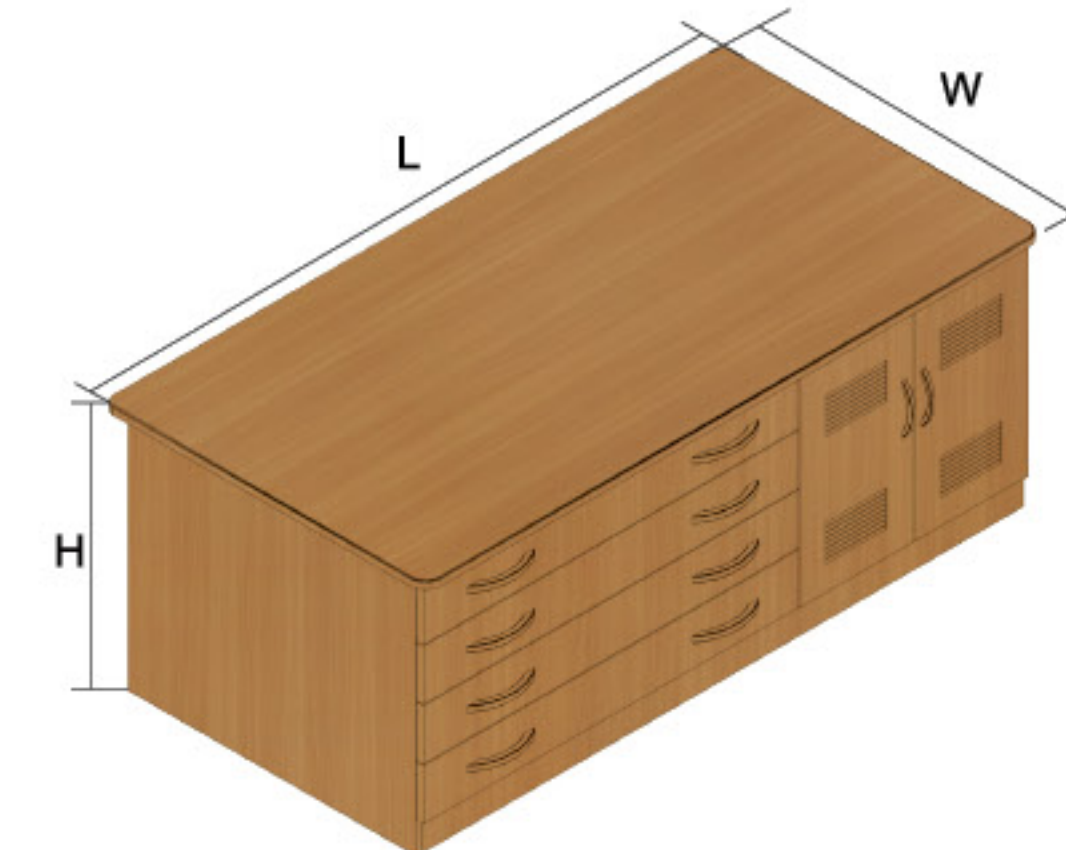

海图桌
Chartb Table

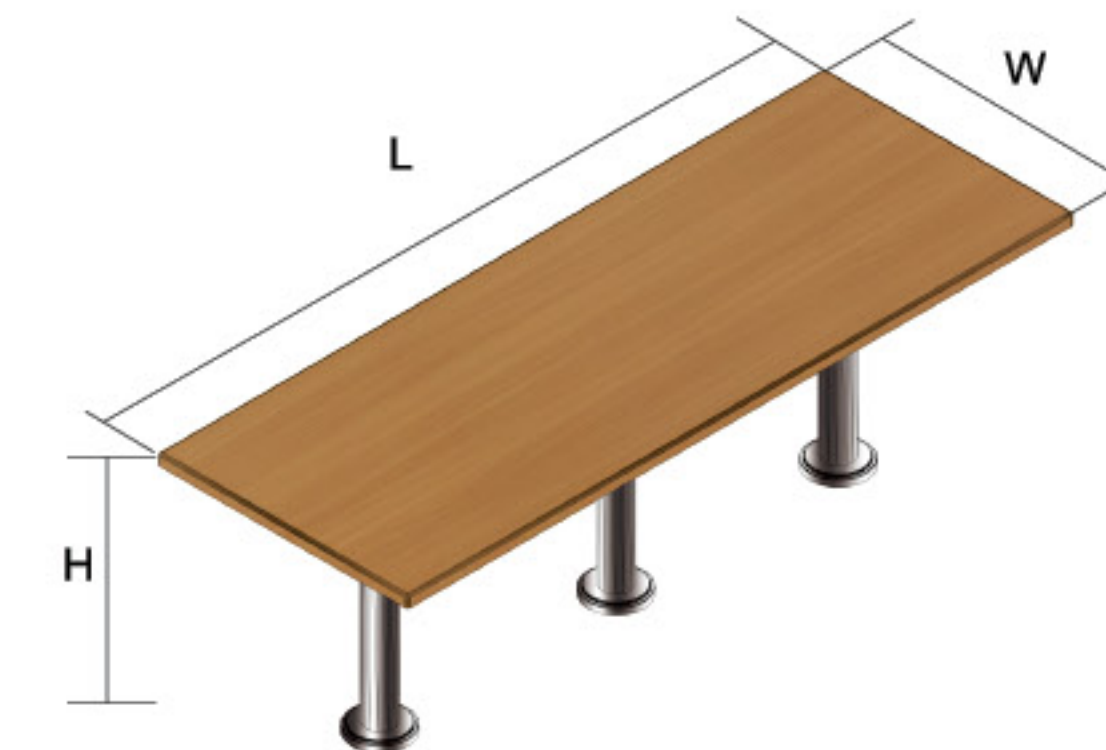

餐桌 01
Dining Table 01

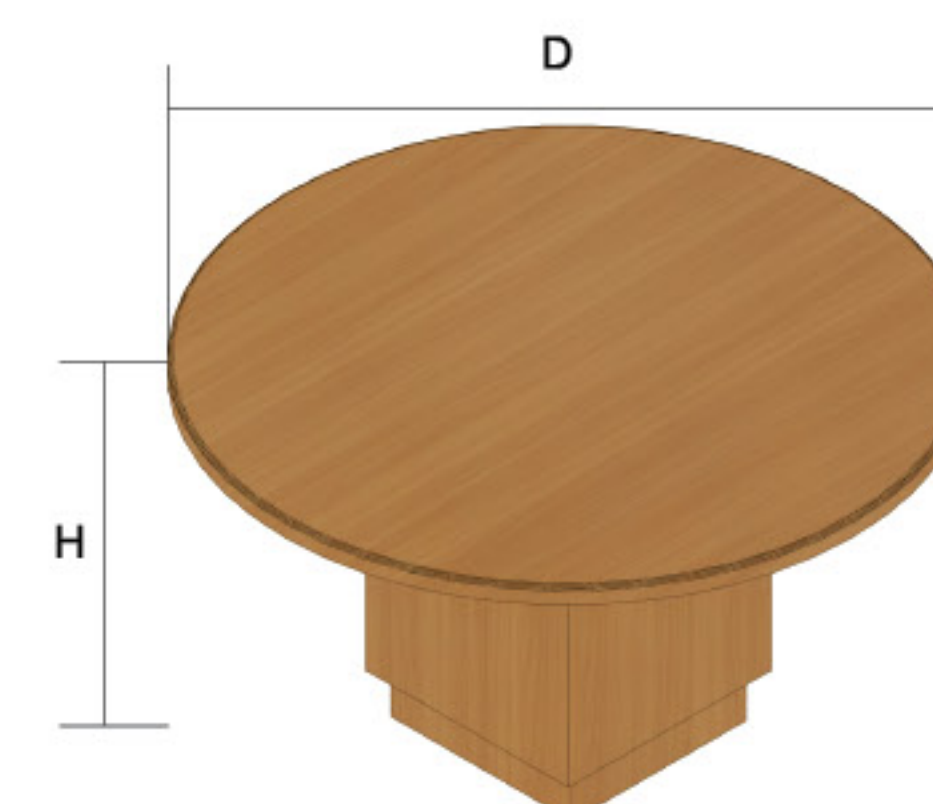

餐桌 02
Dining Table 02

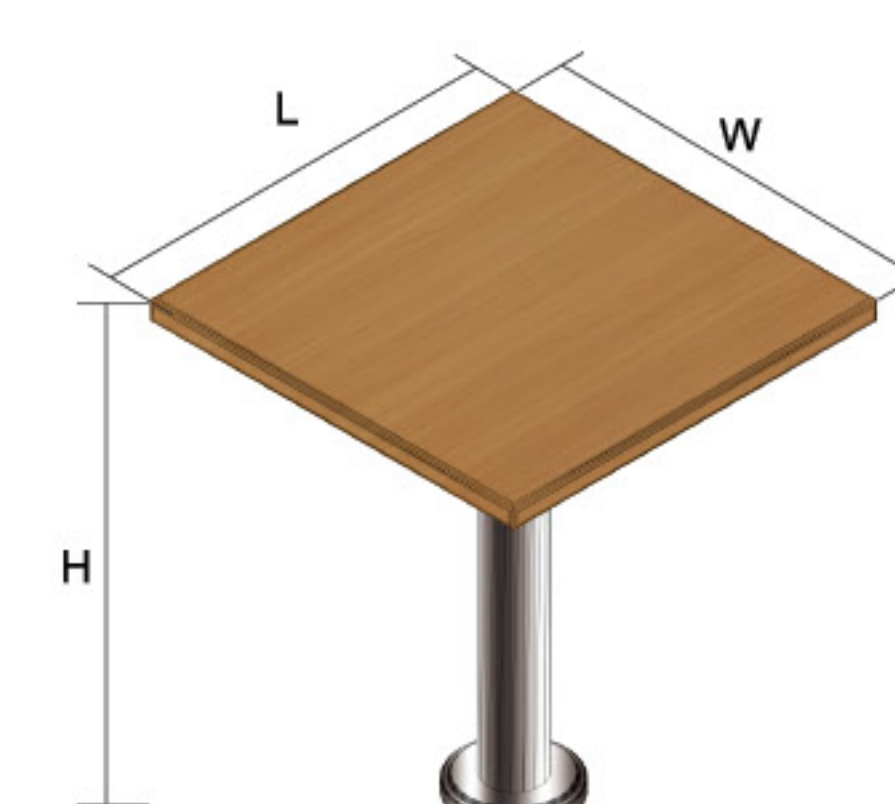

娱乐桌
Entertainment Table

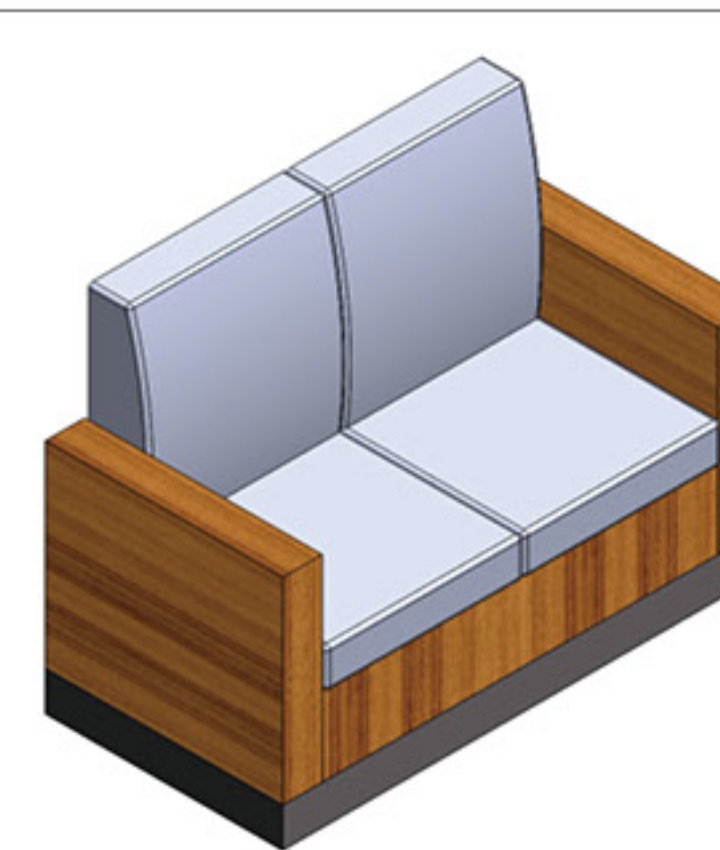

沙发
Safa

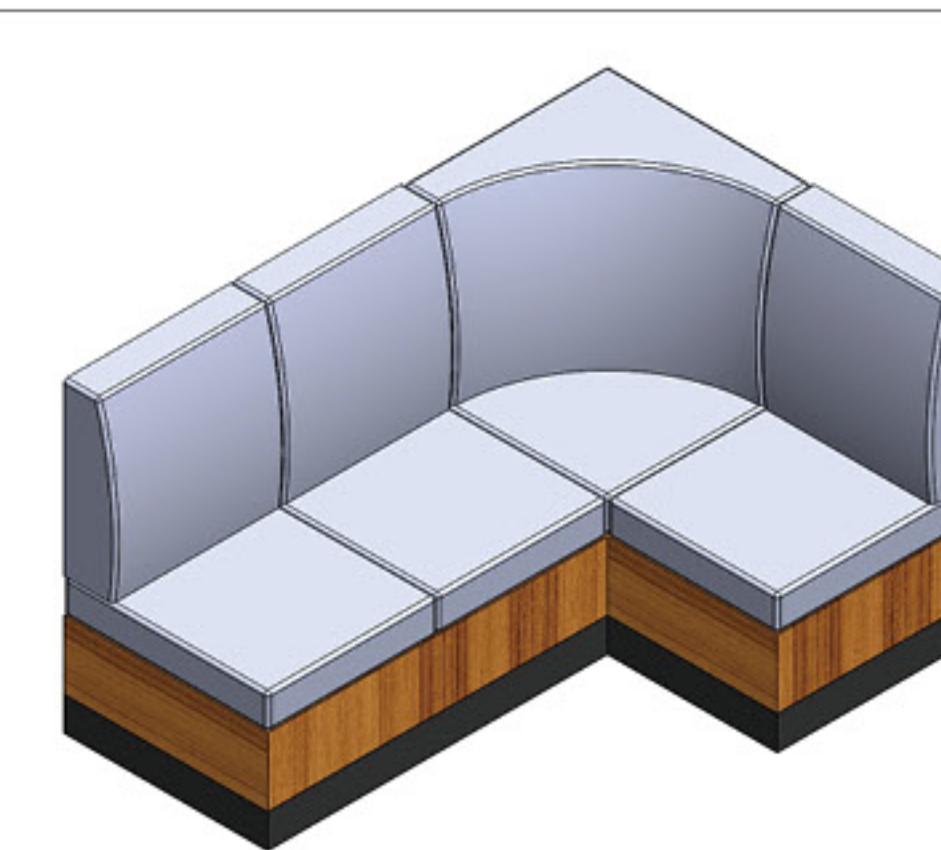

转角沙发
Corner Safa



船用翻床

Marine Trunover Bed

本产品设计紧凑结构合理坚固耐用，不易变形，节约舱室空间。
This product is compact in design, reasonable structure, surable, save space.

打开位置 Open Position

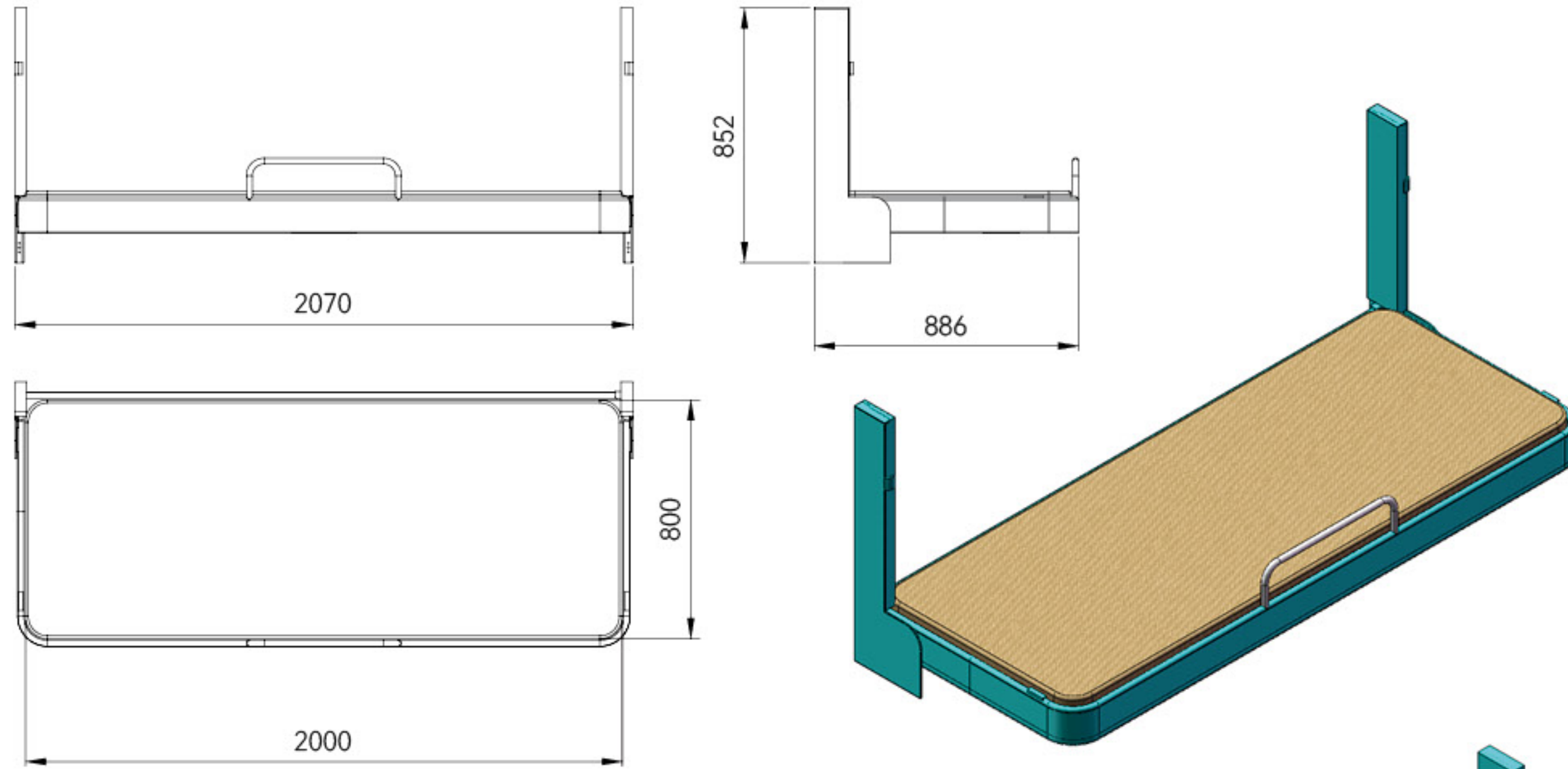

闭合位置 Closed Position

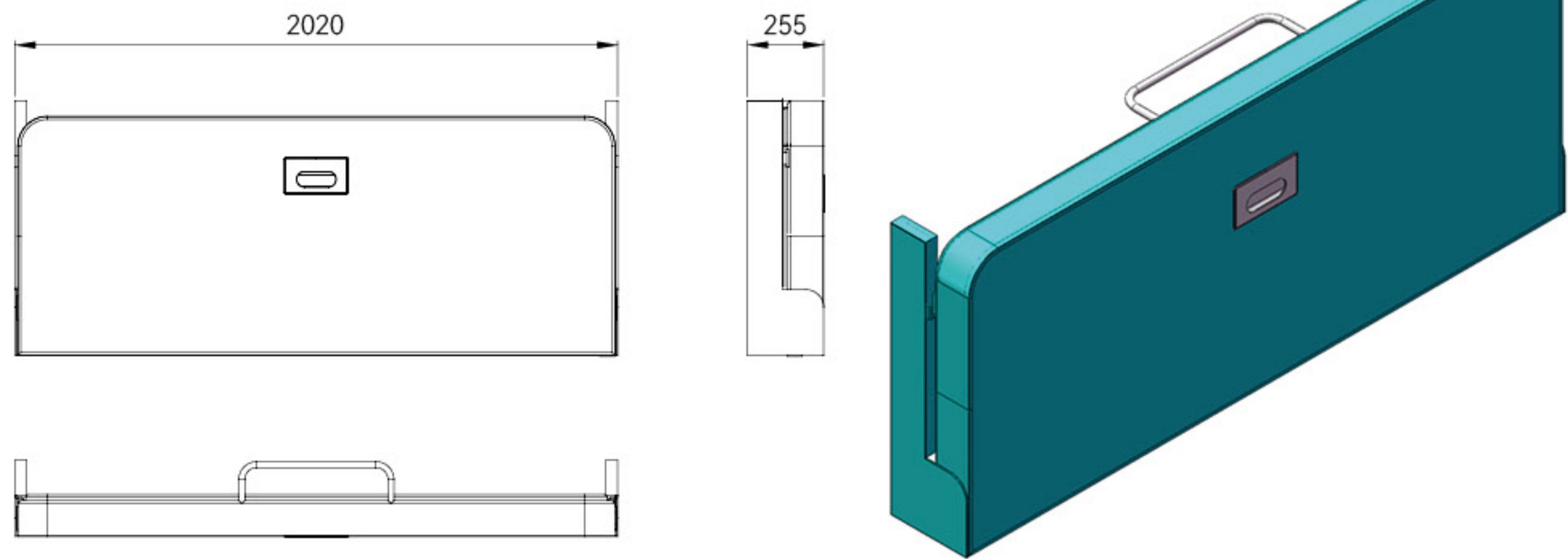

型号 Type	DZFC-A	DZFC-B	DZFC-C
规格尺寸 Size	标准尺寸，或特殊定制 Standard Size, Special Customization		
安装方式 Installation Type	壁挂式 Wall Mounted		
表面处理 Surface Treatment	喷涂。木纹转印 flame Plating, Wood Grain Transfer Printing		
材料 Material	碳钢 Steel	不锈钢 Stainless Steel	铝合金 Aluminium



玻璃隔断

Glazed Wall

玻璃隔断：主要用于甲板边部的阻挡及中间部位的活动场所分隔。
Glazed wall: it is mainly used to block the deck side and separate the activity place in the middle part.

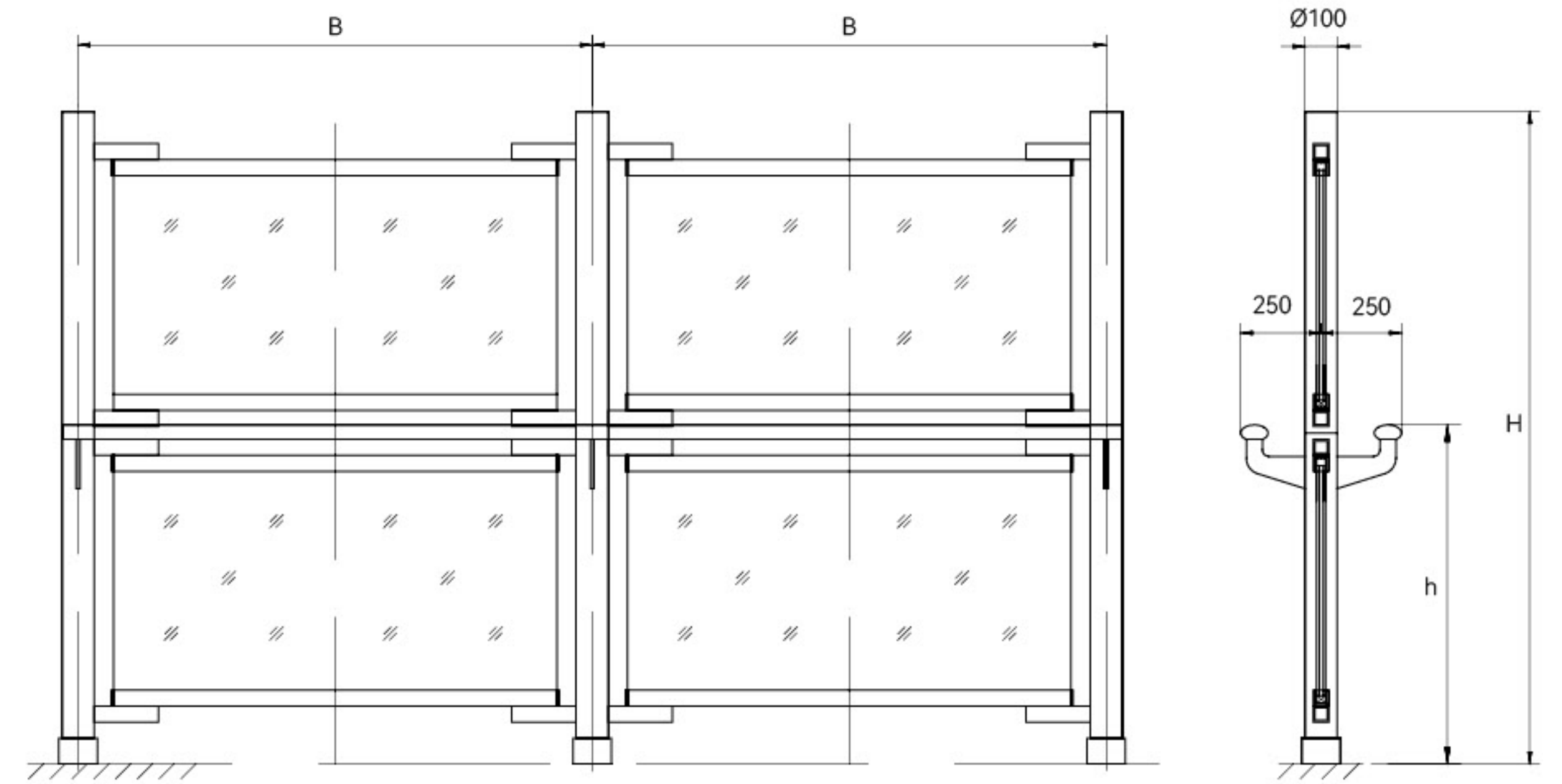

型号 Type	DZGD-A	DZGD-B	DZGD-C
材料 Material	碳钢 Steel	不锈钢 Stainless Steel	铝合金 Aluminium



整体式阳台

Integral Balcony

整体式阳台：主要用于游船和客船等需安装阳台的场合。

主要部件：铝质滑动移门、铝质隔断组件、带玻璃的护栏、地板等组成。

主要特点：安装方便、施工周期短、重量轻、外形统一美观。

Integral balcony: basically use at cruise ship and passenger ship wait for the occasion that needs to install balcony.

Main components: aluminum sliding door, aluminum partition components, glass guardrail, floor and so on.

Main features: easy installation, short construction period, light weight, unified appearance.

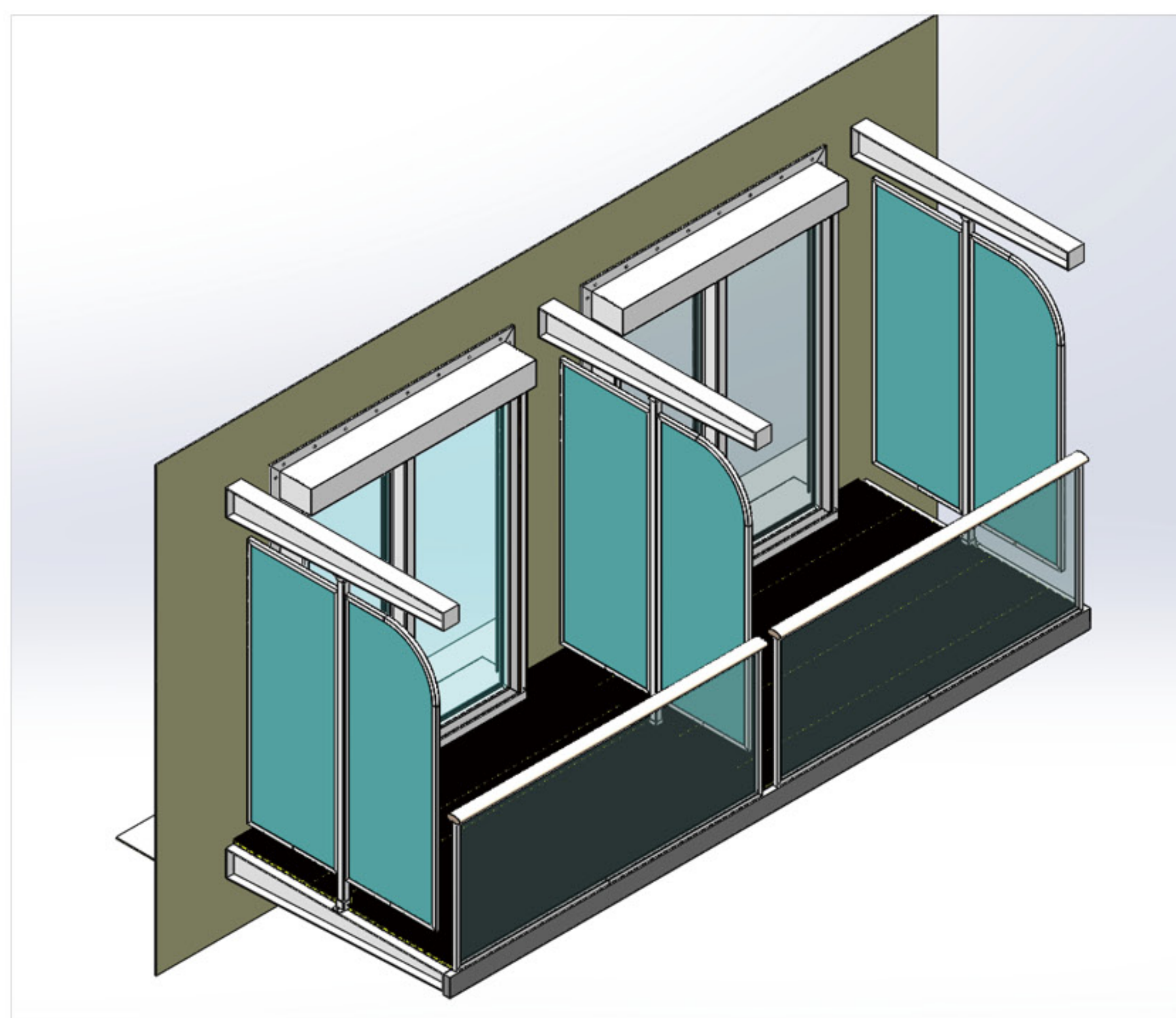

满足邮轮、客船对于阳台指标的设计要求，可为客户定制非标要求的产品。

To meet the design requirements of the balcony index for postal ships and passenger ships, we can customize non-standard products for customers.



不锈钢护栏

Stainless Steel Guard Bar

甲板边部的护栏

Guard Bar At The Side Of The Deck





冷库及气调保鲜 DZLK-00

Cold Storage And Air Conditioning Preservation

拼装式库体

公司产品采用结构简单的各种模块与组合件组成的装配式库体。另外为适应船体结构特点及船舶航行中的倾斜、摇摆、振动的因素，故在装配现场还需采取有效措施，使库体整体得到良好的定位和固定。

库板的基本结构为两边薄金属板，中间为发泡隔热材料所组成。其面板为不锈钢板，背面为镀锌板或镀塑彩板，中间隔热材料为导热系数低、充模性好、比重轻、强度高的阻燃型硬质聚氨酯泡沫塑料。

库板可按库顶板、库地板、周墙板及隔墙板等不同用途，采用不同的平板结构和厚度。

库板厚度：100mm~120mm

独立壁：≥ 150mm

库板间的接合为凹凸型配合，使其定位更和谐，拼装平整。



冷藏门

气密、铰链可调式、PVC 门框架，两面贴不锈钢薄板或复塑板，内芯用硬质聚氨酯材料，门还带软塑料密封条，提高气密性。

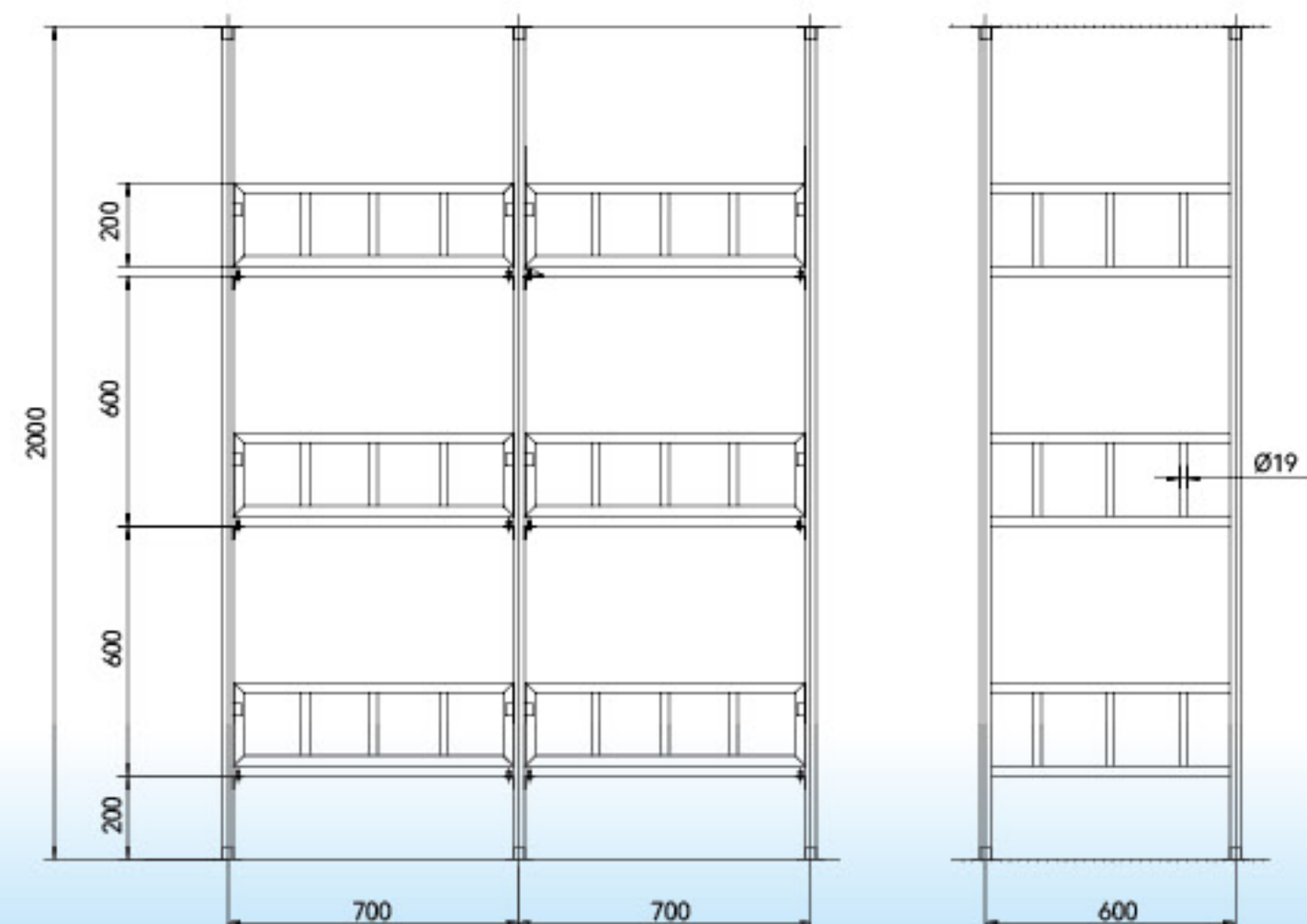

搁架

说明：本产品为库体的配套而设计，具体尺寸根据库体容积而定，也可根据客户需要进行设计，生产各种搁架、托盘。具有美观、简洁、放取方便、安装简单、牢固等特点。



冷库及气调保鲜 DZLK-00

Cold Storage And Air Conditioning Preservation

气调保鲜原理

在一定的封闭库内，根据储藏食品的不同，通过各种调节方式得到不同于正常大气组成的调节气体，以此来抑制食品本身引起食品劣变的生理生化过程或抑制作用于食品的微生物活动过程，从而降低储藏蔬果的有氧呼吸来减缓蔬果的成熟衰老，使蔬果达到理想的保鲜效果。调节气体一般采用分为：低氧、高二氧化碳分压的气、高氧、高二氧化碳分压的气体、纯度较高的氮气等。

气调保鲜装置的组成

一般由气密库体、气调系统、制冷系统、加湿系统、压力平衡系统、及温度、湿度、O₂、CO₂ 等气体自动检测控制系统构成。可根据客户要求增加乙烯脱除装置，蔬果灭菌装置等设备。

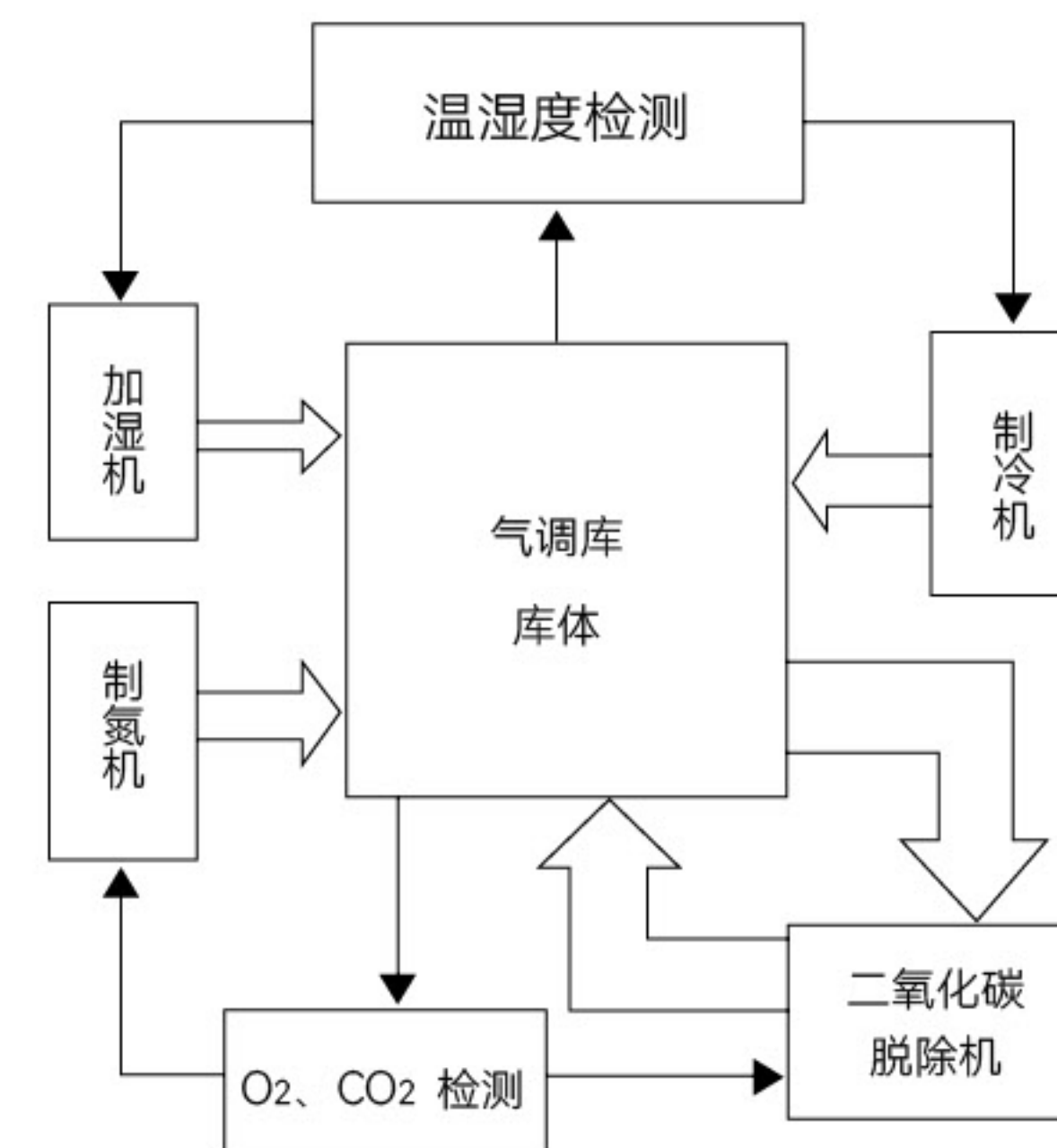



冷库及气调保鲜 DZLK-00

Cold Storage And Air Conditioning Preservation

产品介绍

型号	DZQT-1	DZQT-2	DZQT-3
适用库容	10~50m ³	适用于各种库容冷库	
保鲜产品	多种类水果和蔬菜		
充氮至保鲜浓度时间	≤ 6h		
增氧至保鲜浓度时间	≤ 10min		
库内湿度	75~95% RH (可调)		
保鲜周期	绿叶蔬菜以生菜为例可保鲜 30 天以上		
功能	制氮、乙烯脱除、加湿、安全保护	氮气减压分流、乙烯脱除、加湿、安全保护	

乙烯脱除装置

乙烯脱除装置分两种形式：

一体机：集气调保鲜控制系统与乙烯脱除装置集成一体，操纵面板在户外。

分体机：乙烯脱除装置与控制装置分开安装，脱除装置安装在库内，控制系统安装在库门口。

型号	DZQT-YX
气调库内乙烯控制范围	≤ 2 ppm
气体处理量	30m ³ /h
库内湿度	75~95% RH (可调)
保鲜周期	绿叶蔬菜以生菜为例可保鲜 15~20 天以上
功能	乙烯脱除、加湿、除异味、杀菌消毒



复合岩棉板

Composite Rock Wool Board

与复合岩棉板配套的舱室防火门，见本公司门窗盖样本。

For the cabin fire door matched with composite rock wool board, see the sample of door, window and cover of our company.

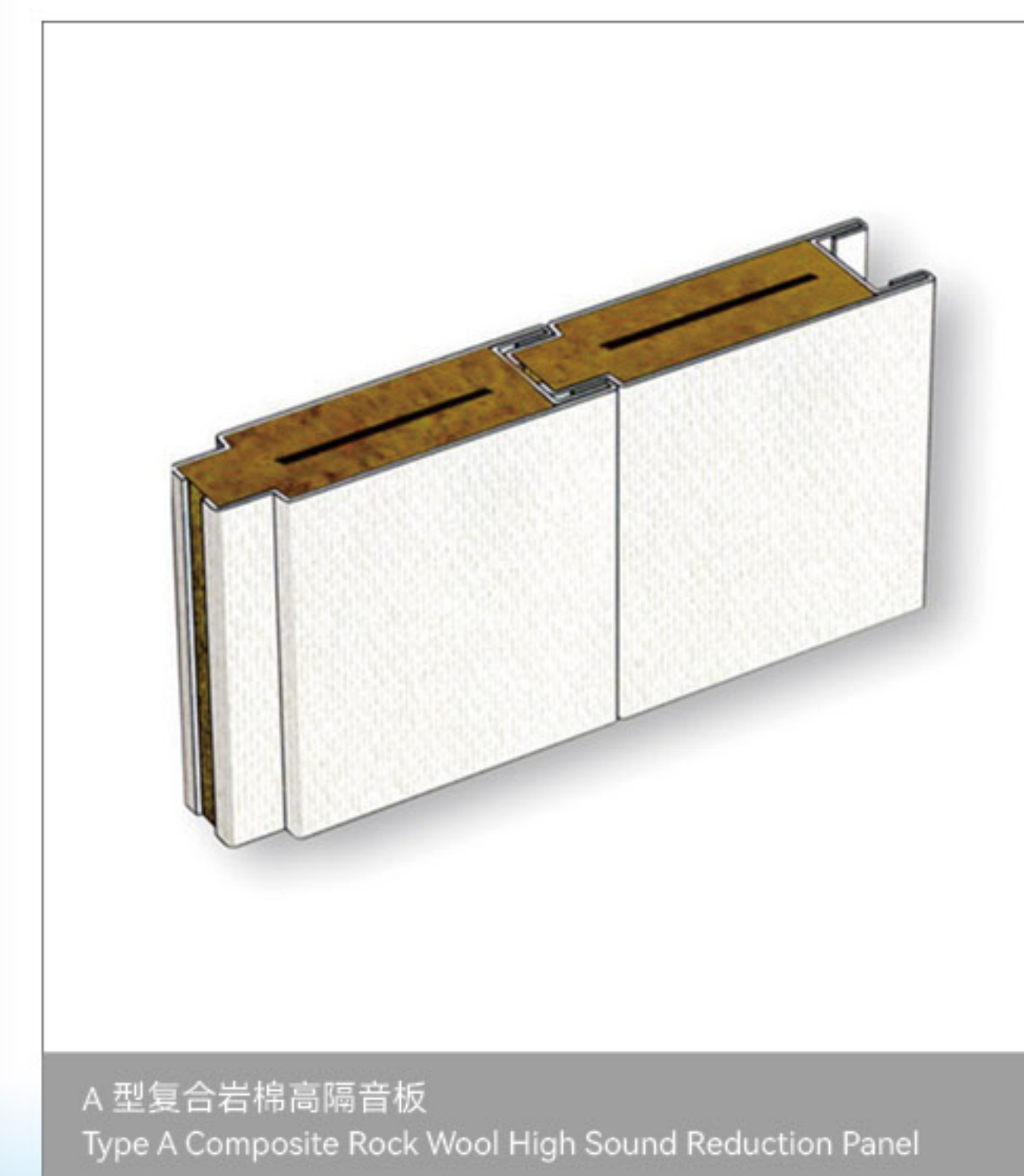



复合岩棉板

Composite Rock Wool Board

与复合岩棉板配套的舱室防火门，见本公司门窗盖样本。

For the cabin fire door matched with composite rock wool board, see the sample of door, window and cover of our company.

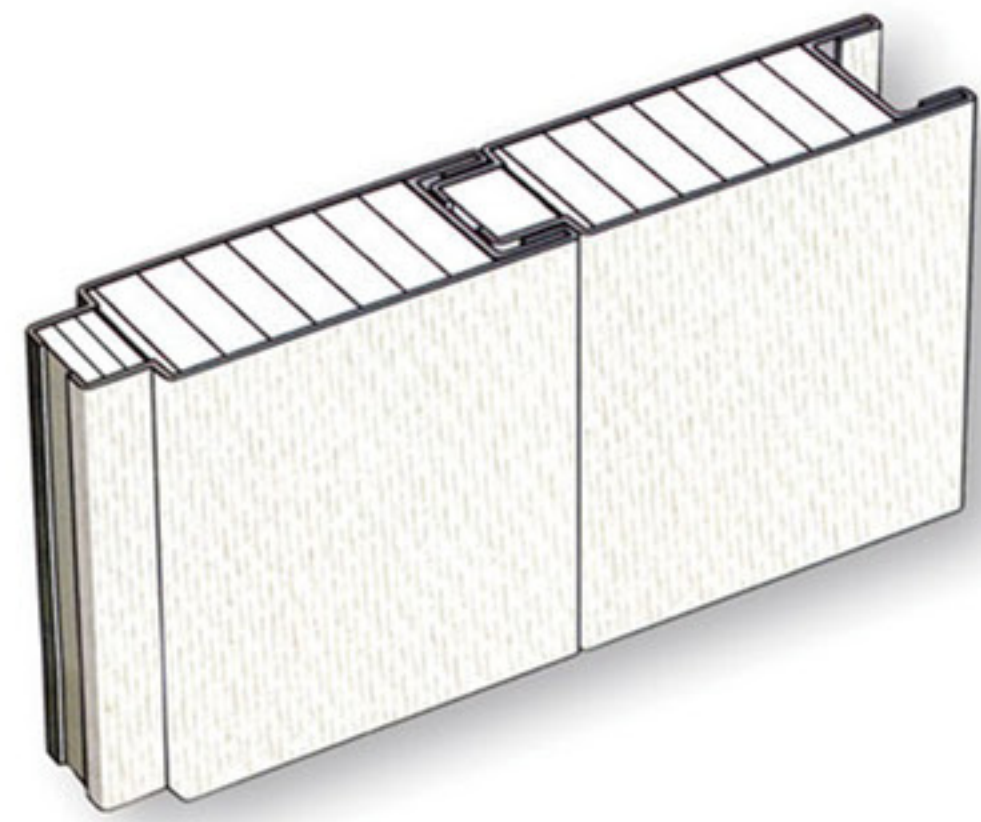

A 型钢质复合铝蜂窝板
Type A Steel Sheet Composite Aluminum Honeycomb Wall Panel

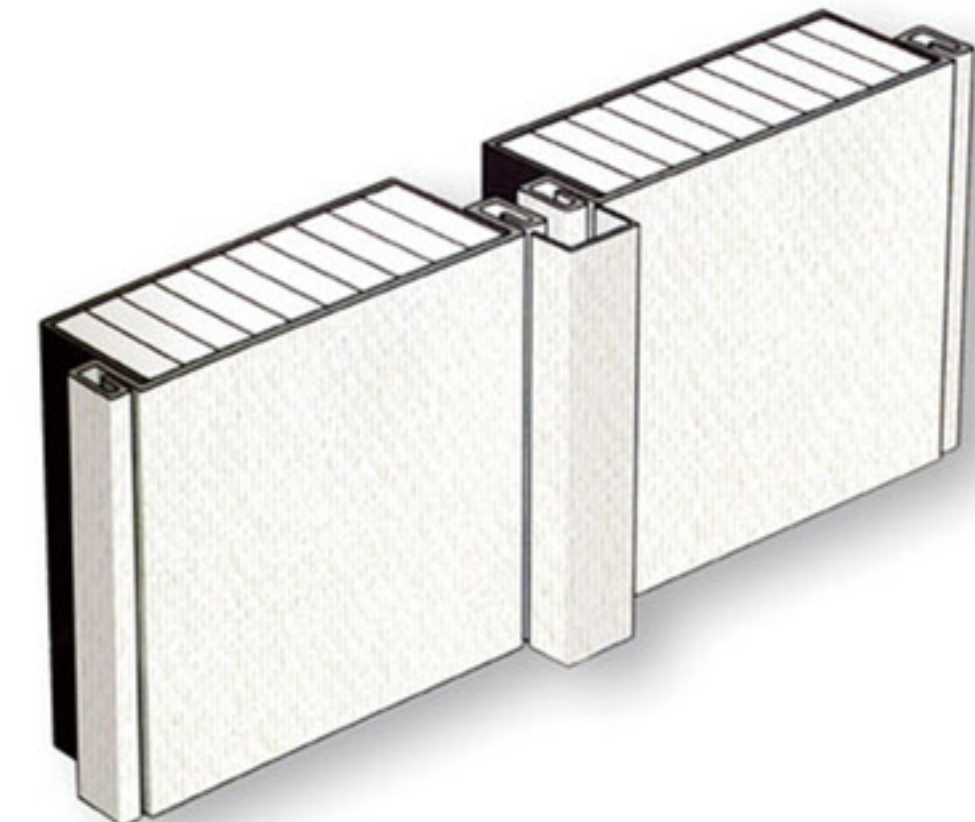

C 型钢质复合铝蜂窝板
Type C Steel Sheet Composite Aluminum Honeycomb Wall Panel

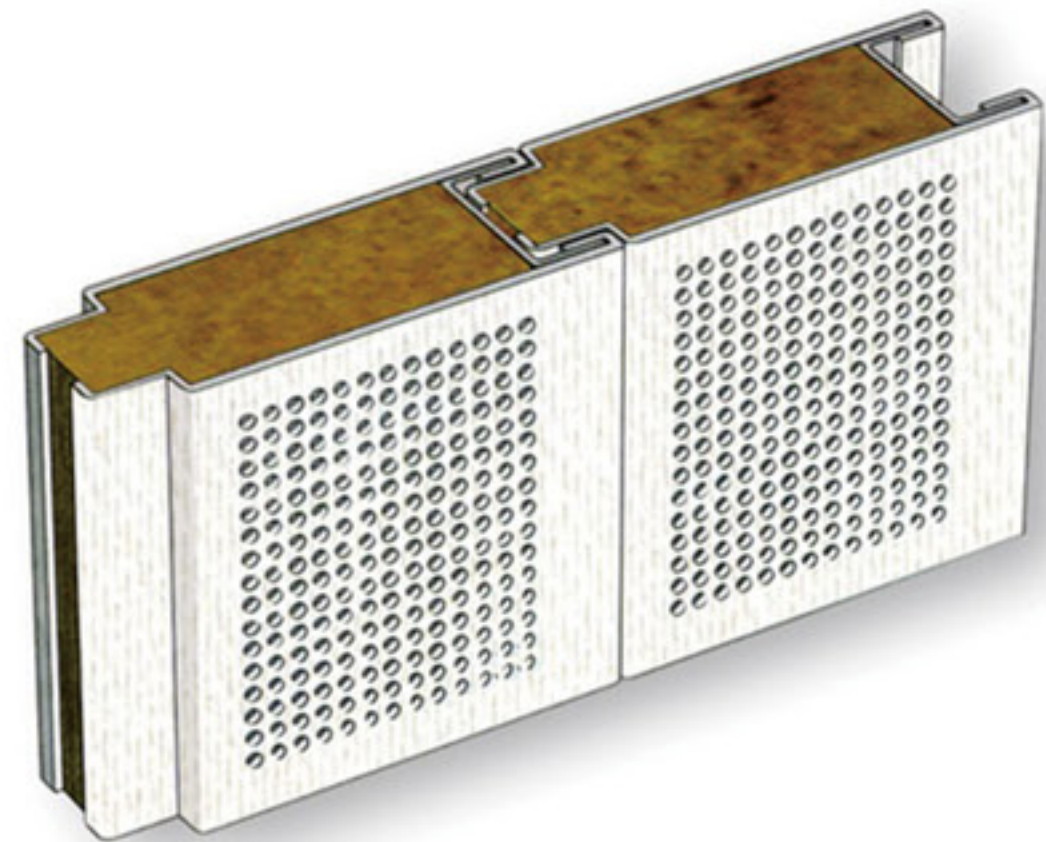

A 型复合岩棉吸音板
Type A Composite Rock Wool Perforated Sound Reduction Panel

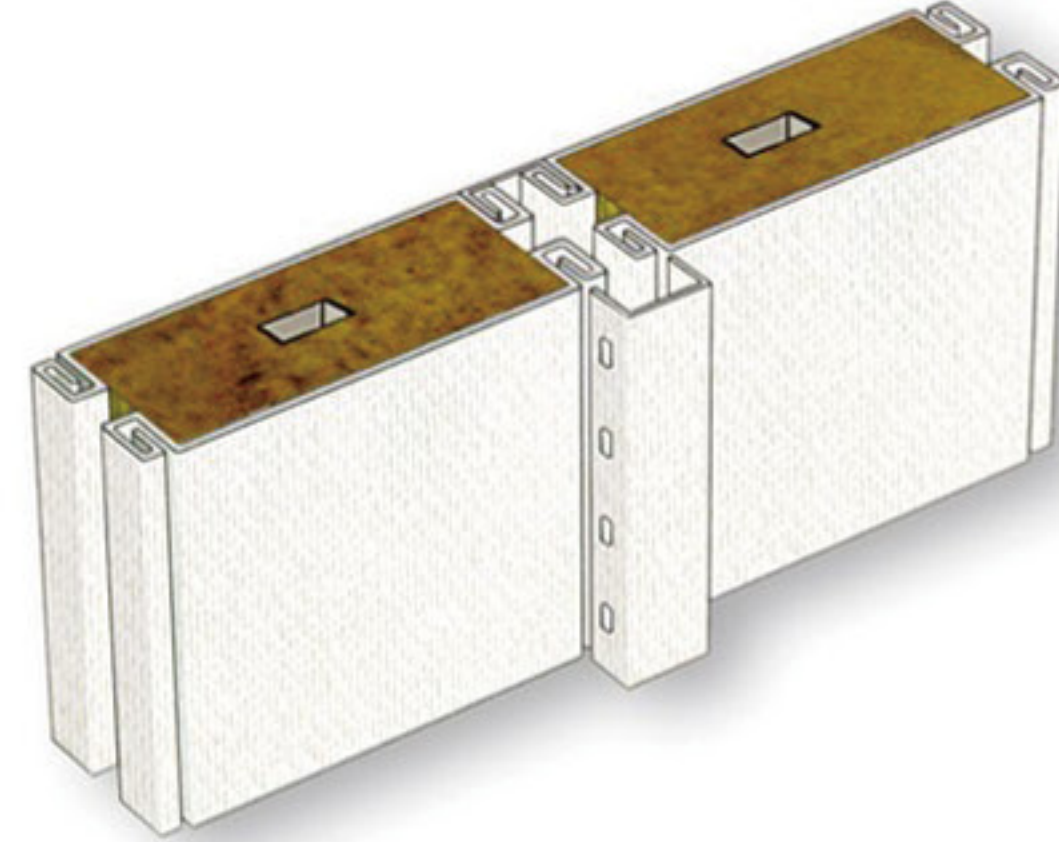

C 型带电缆槽复合岩棉板
Type C Composite Rock Wool Panel (With Cable Slot)



复合岩棉板

Composite Rock Wool Board

与复合岩棉板配套的舱室防火门，见本公司门窗盖样本。

For the cabin fire door matched with composite rock wool board, see the sample of door, window and cover of our company.

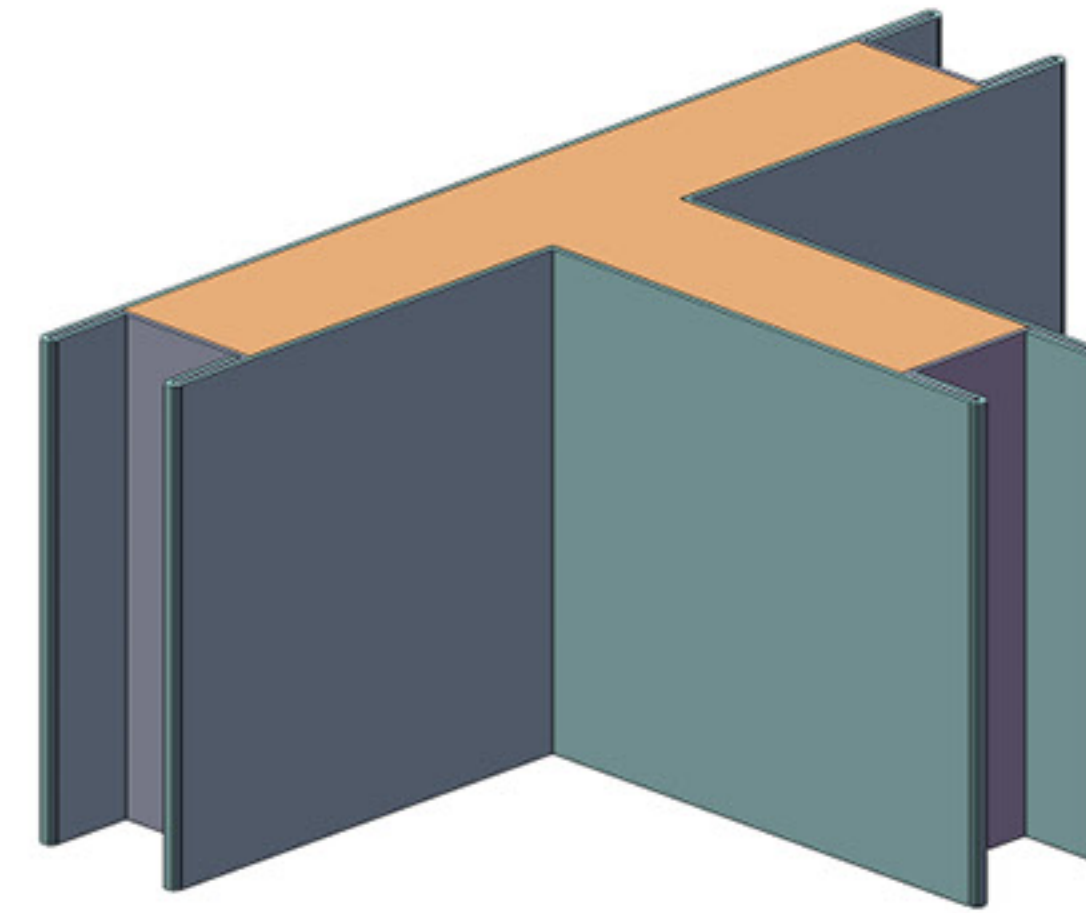

A 型板 T 型转角板
Type A Panel T Corner

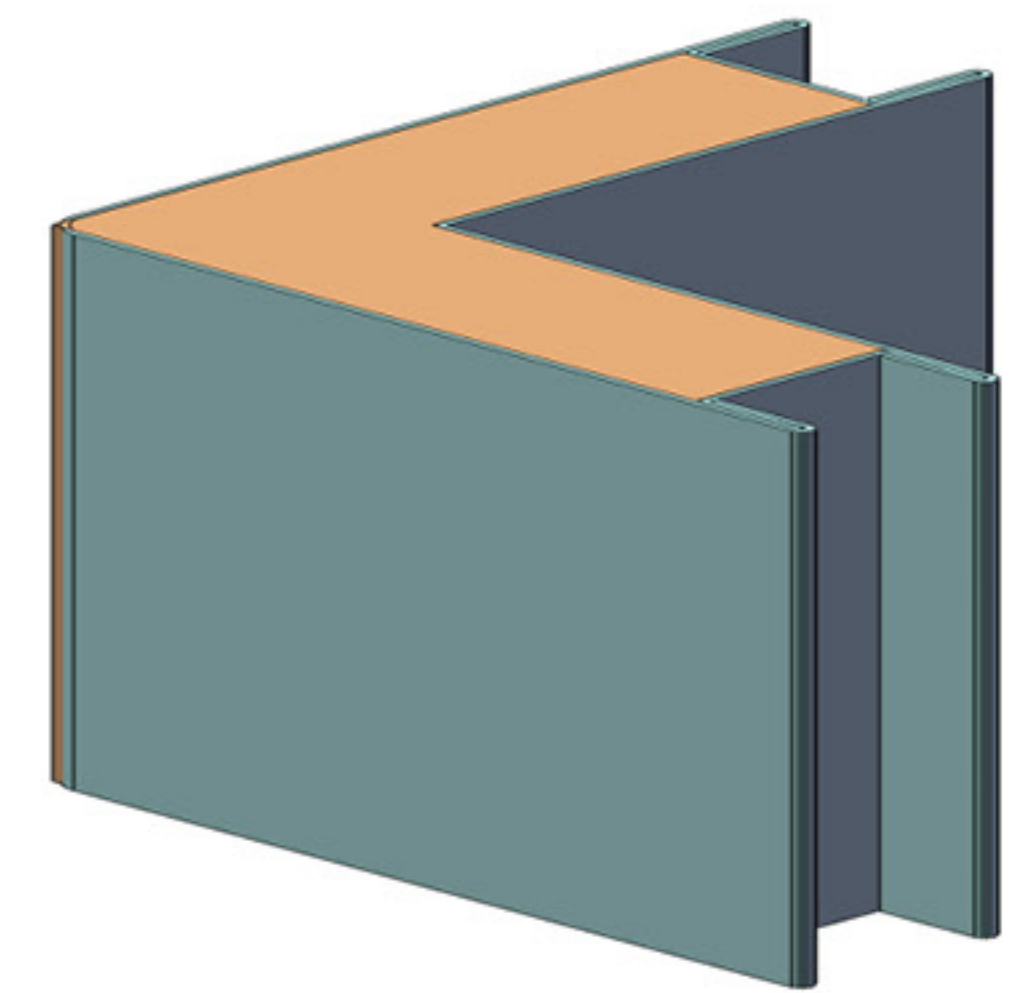

A 型板 L 型转角板
Type A Panel L Corner

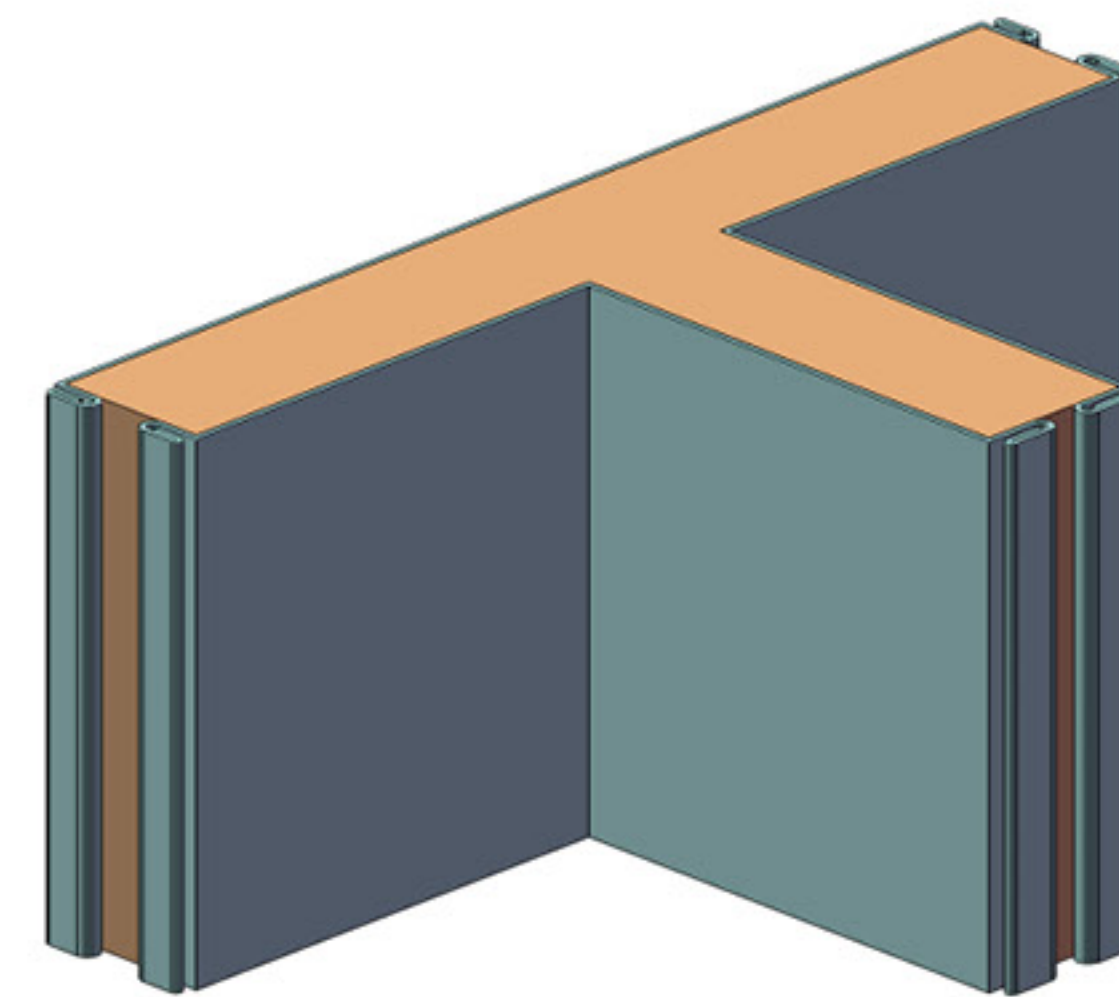

C 型板 T 型转角板
Type C Panel T Corner

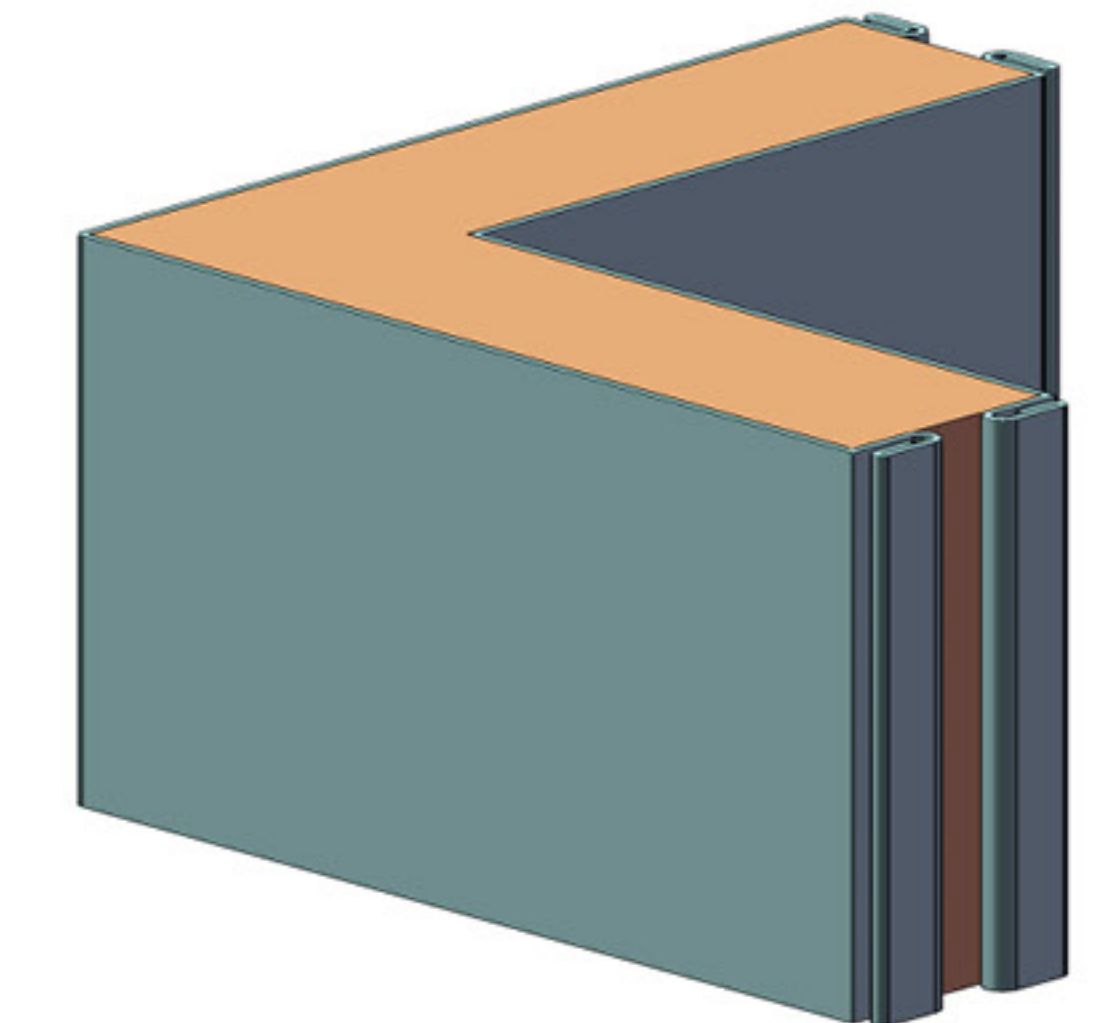

C 型板 L 型转角板
Type C Panel L Corner



复合岩棉板

Composite Rock Wool Board

与复合岩棉板配套的舱室防火门，见本公司门窗盖样本。

For the cabin fire door matched with composite rock wool board, see the sample of door, window and cover of our company.

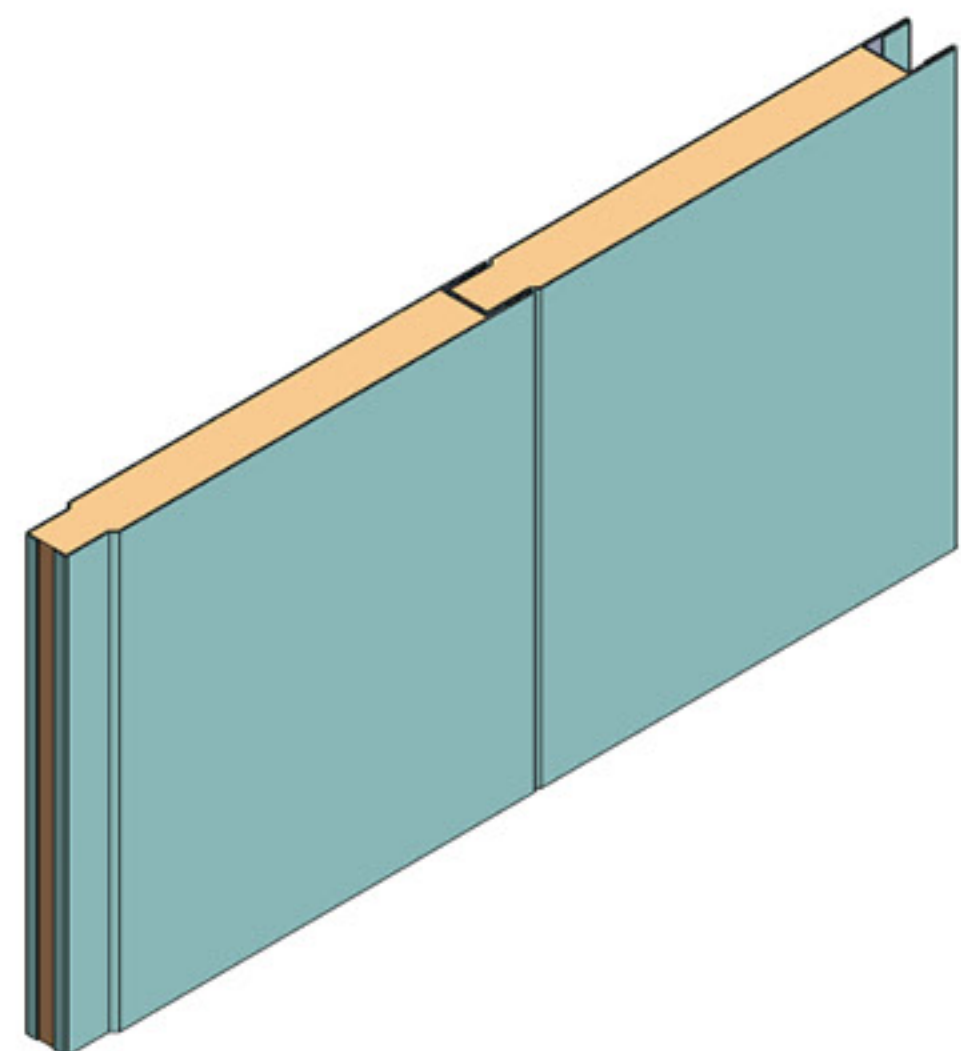

A 型复合岩棉天花板
Type A Composite Rock Wool Ceilings

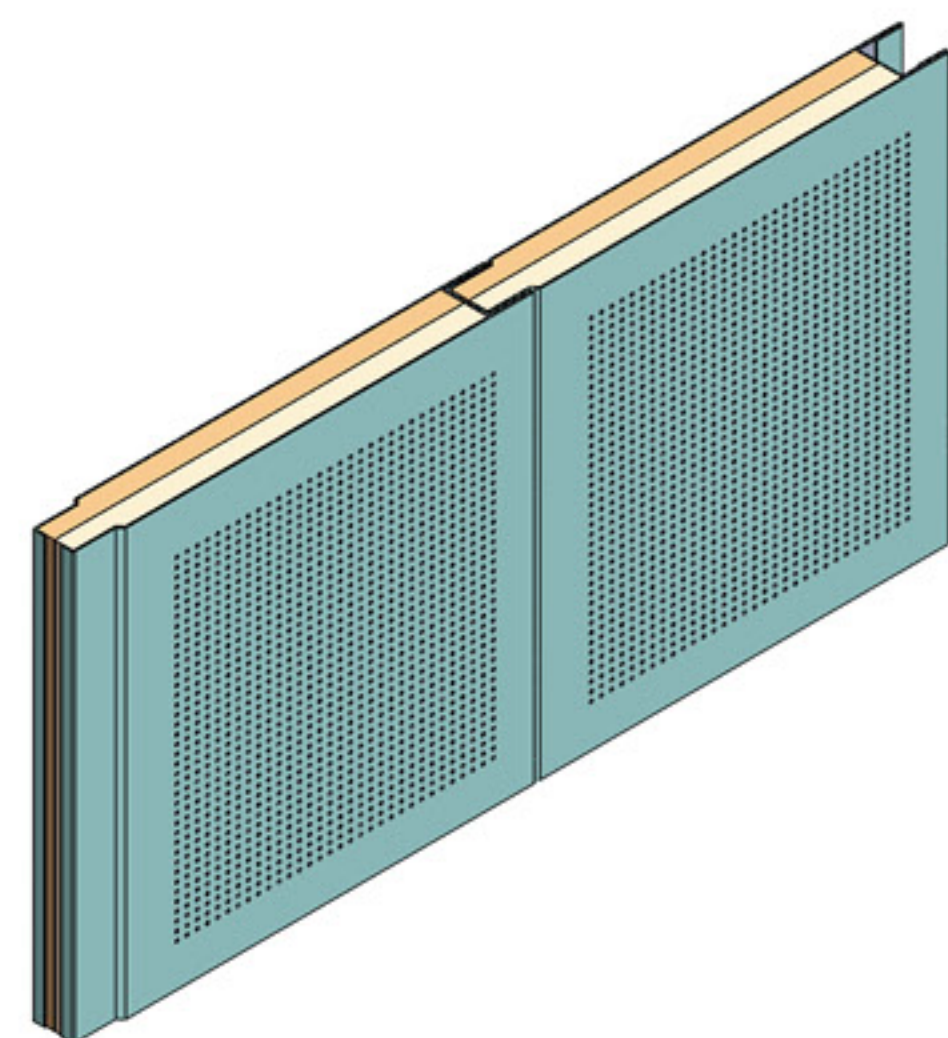

A 型复合高性能吸隔音天花板
Type A Composite High-Performance Sound-Reduction And Insulation Ceiling

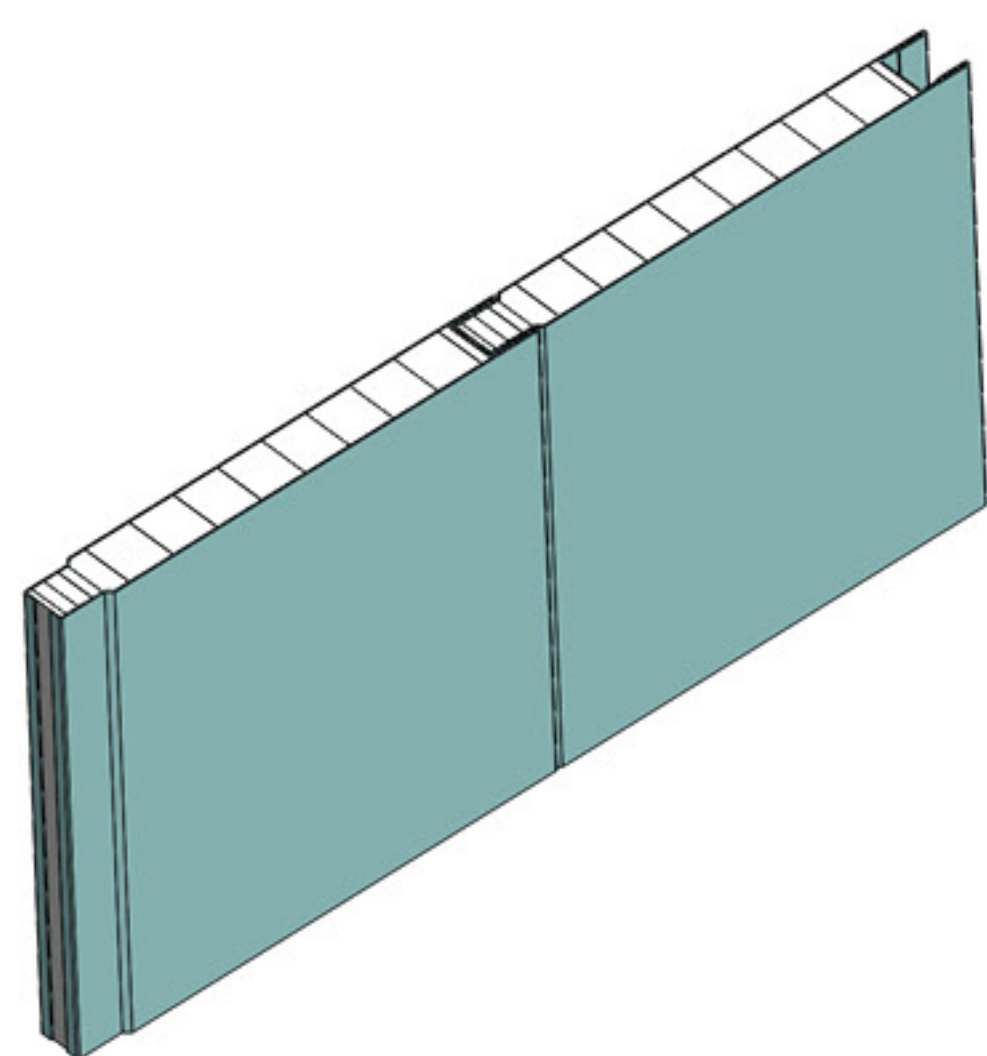

A 型复合铝板铝蜂窝天花板
Type A Composite Aluminum Sheet Cellular Honeycomb Ceilings

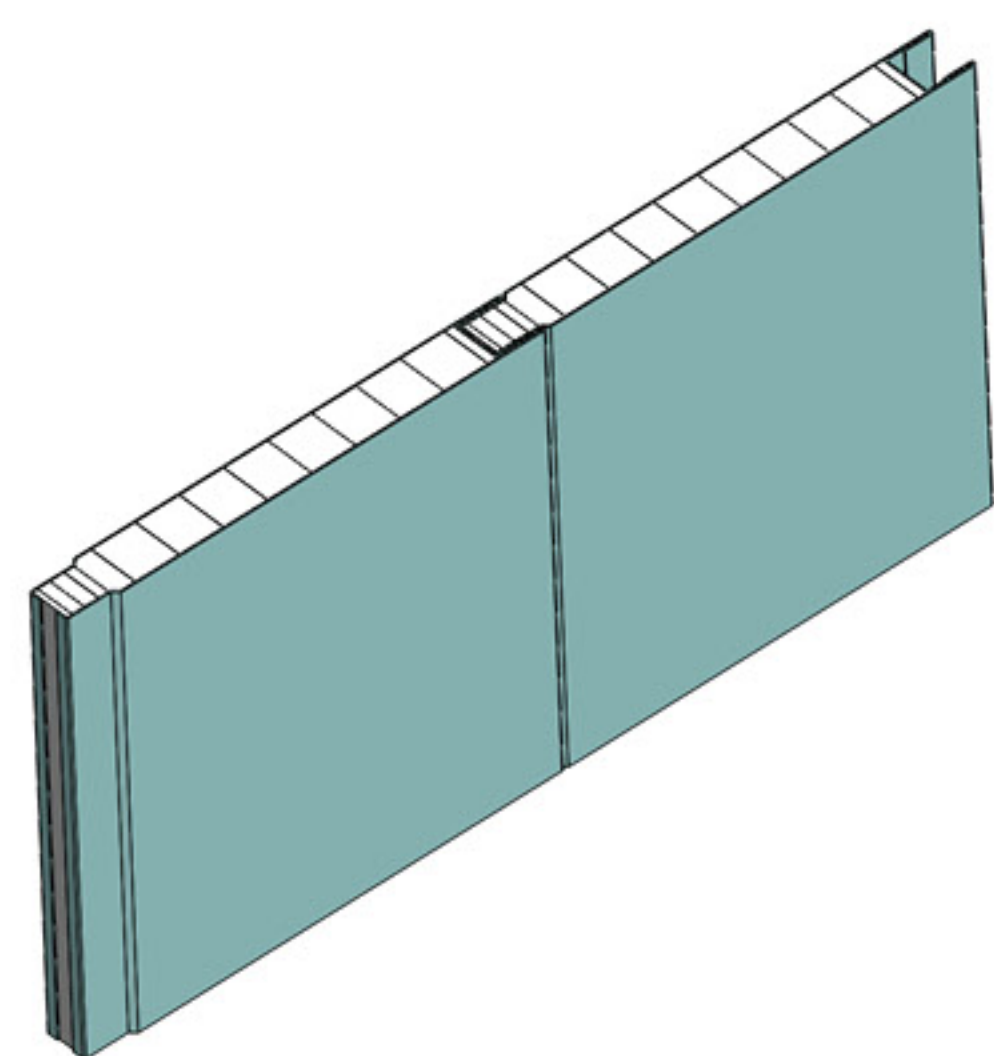

A 型钢质复合铝蜂窝天花板
Type A Steel Sheet Composite Aluminum Honeycomb Ceilings



内装工程

Interior Decoration Engineering

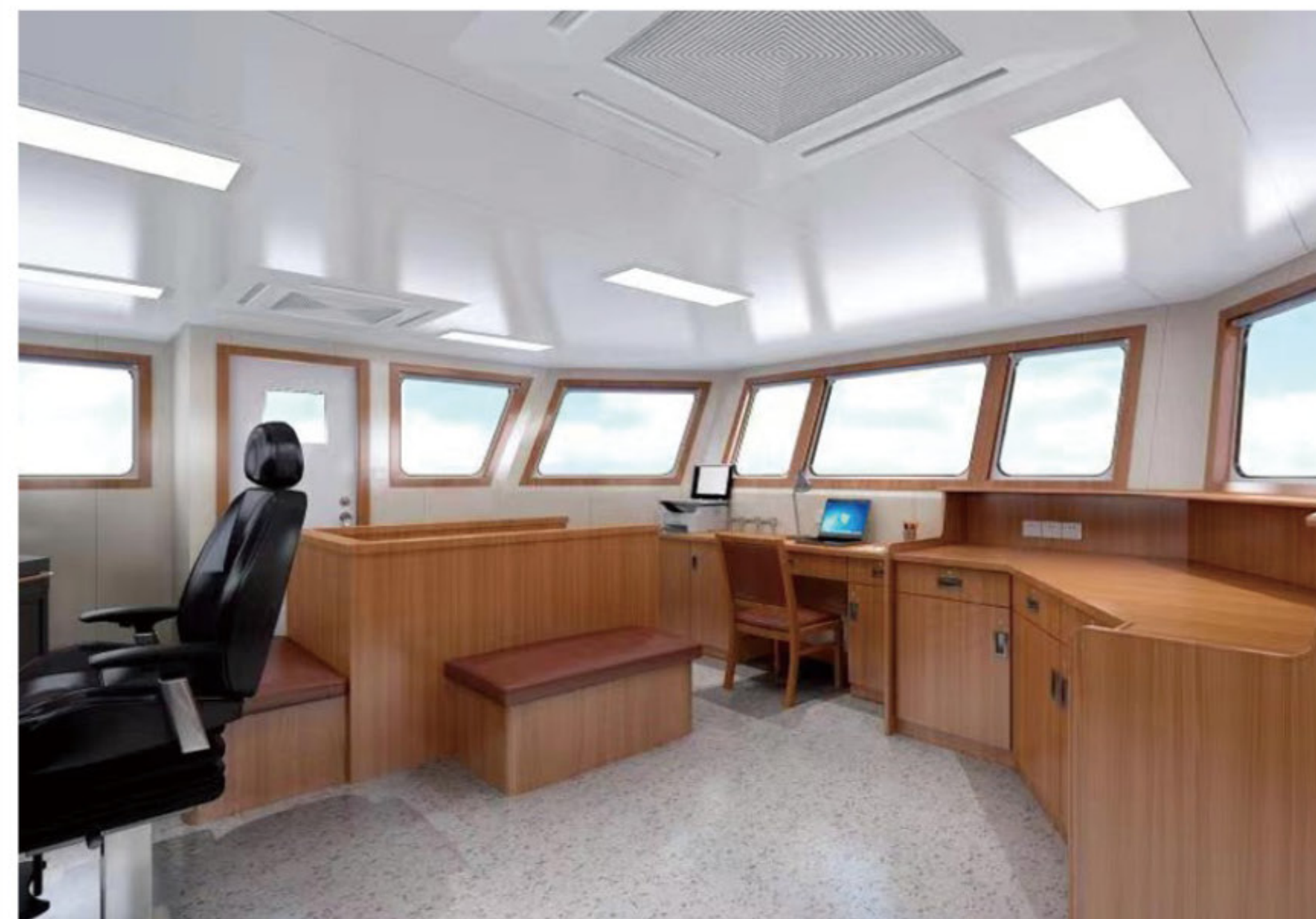

驾驶室
Wheel House

舱室
Bedroom



洗手间
Toilet



内装工程

Interior Decoration Engineering



餐厅
Dining Room

会客室
Meeting Room



小五金

Hardware



DZWJ-01 带扣毛巾架

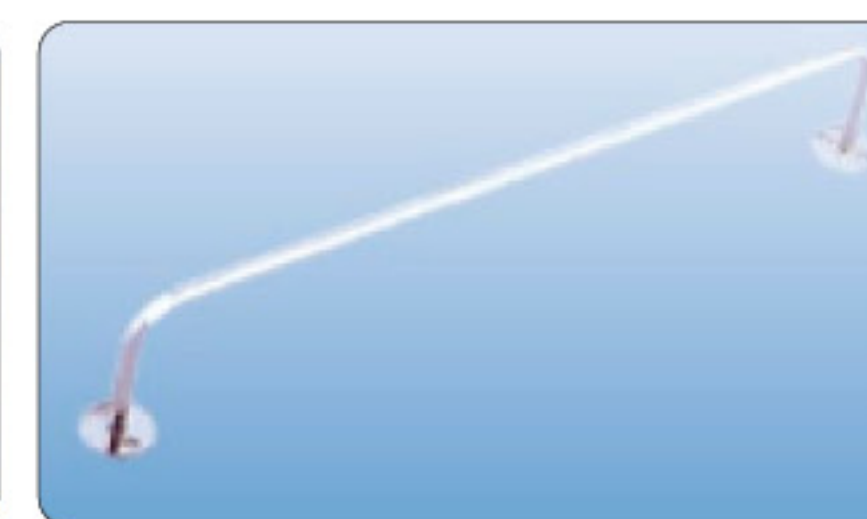

DZWJ-02 圆杆毛巾架



DZWJ-03 三杆毛巾架



DZWJ-04 热水瓶架



DZWJ-05 冷水瓶架

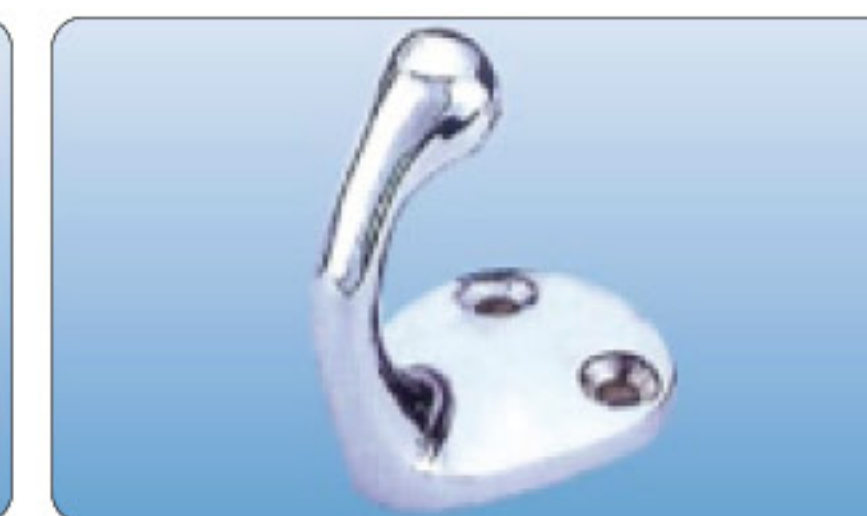

DZWJ-06 衣帽钩



DZWJ-07 衣帽钩

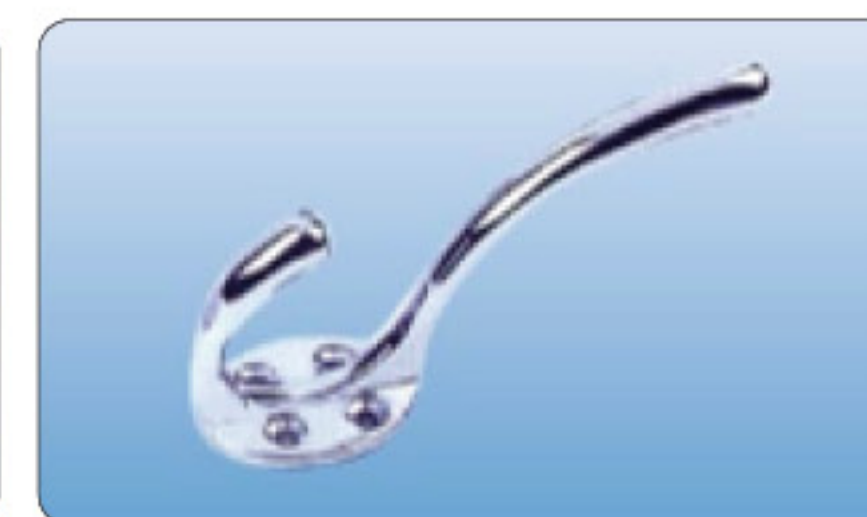

DZWJ-08 衣帽钩



DZWJ-09 肥皂架

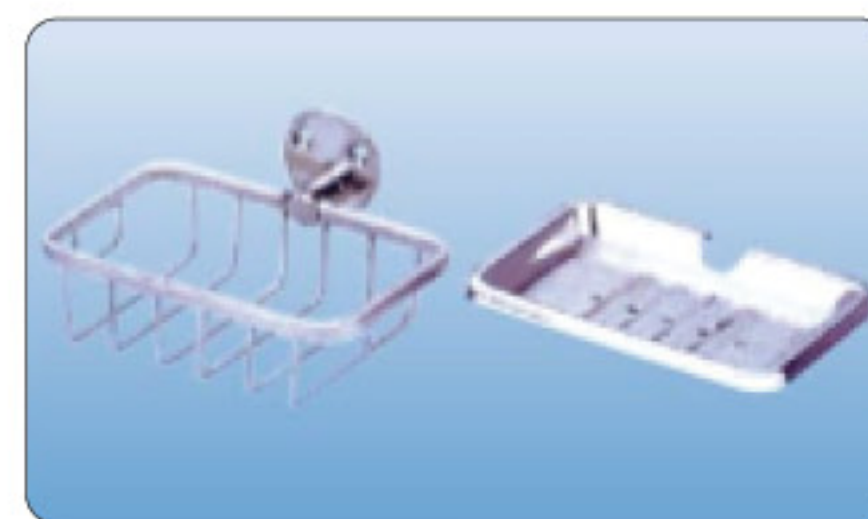

DZWJ-10 肥皂架



DZWJ-11 防浪扶手



DZWJ-12 防浪钩



DZWJ-13 防浪钩



DZWJ-14 防浪钩



DZWJ-15 定门器



小五金

Hardware



DZWJ-16 定门器



DZWJ-17 门钩

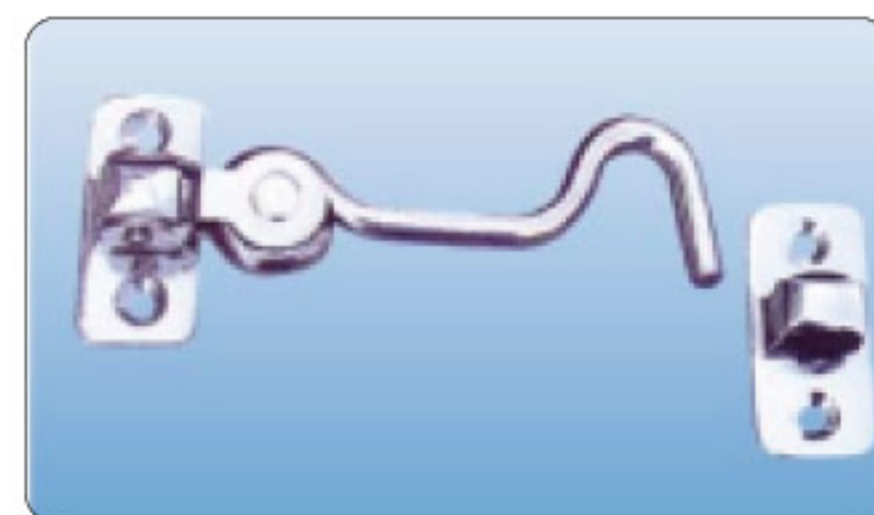

DZWJ-18 门钩



DZWJ-19 双毛中钩

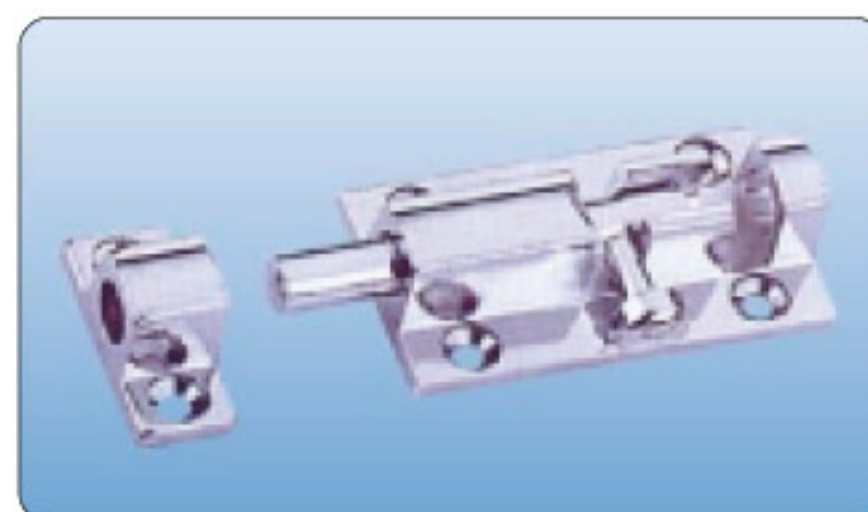

DZWJ-20 杆销



DZWJ-21 领带梗



DZWJ-22 风暴扶手托架



DZWJ-23 楼梯扶手托架



DZWJ-24 海图桌扶手支架

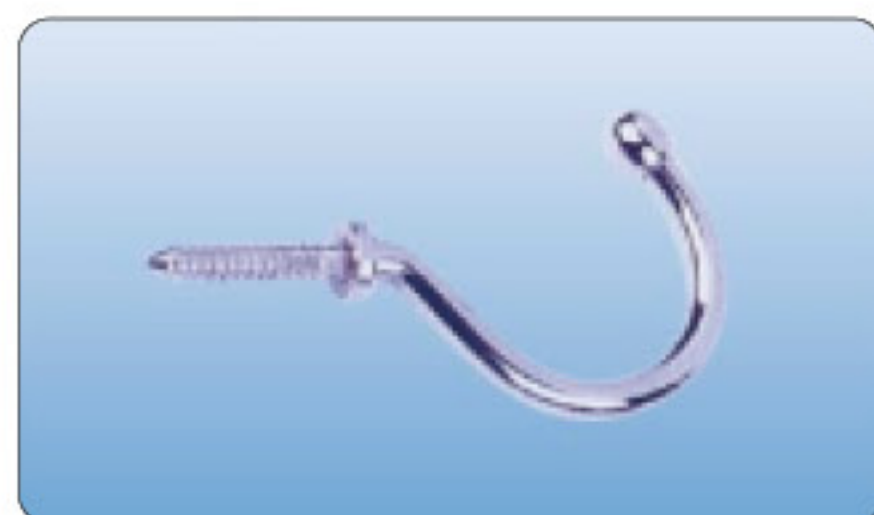

DZWJ-25 杯钩



DZWJ-26 杯钩



DZWJ-27 卡片槽



DZWJ-28 钥匙钩



DZWJ-29 镜面箱

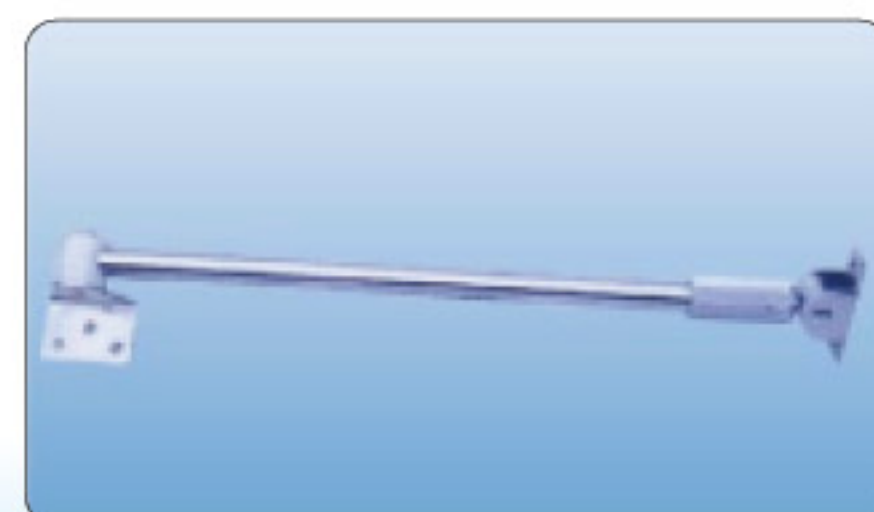

DZWJ-30 限位器



船用椅子

Marine Chair



DZYZ-01
圈椅



DZYZ-02
转椅

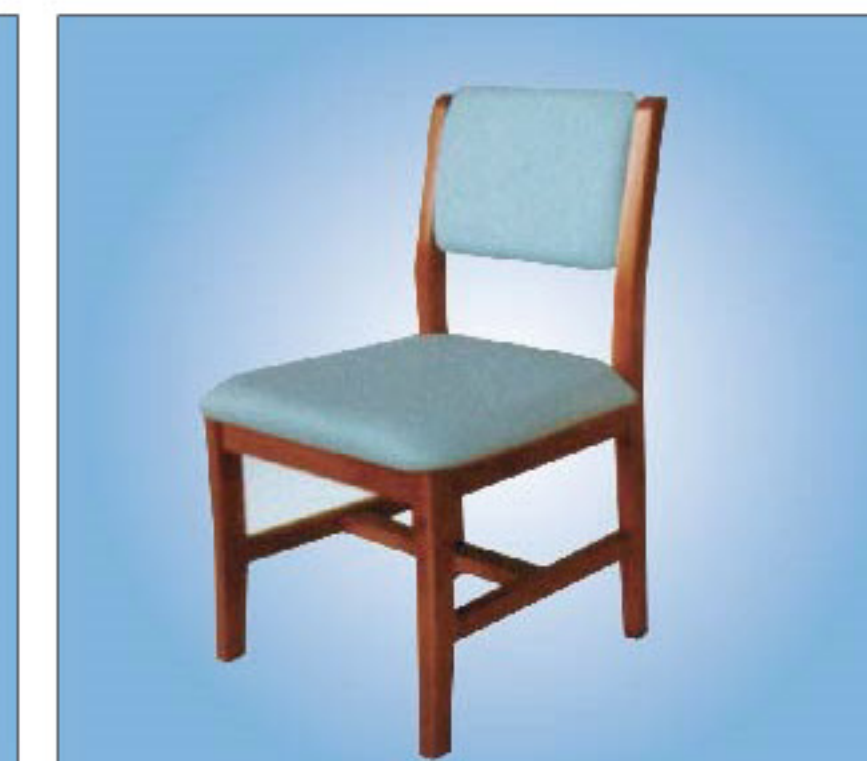

DZYZ-03
靠背椅 A



DZYZ-04
扶手椅 A



DZYZ-05
靠背椅 B

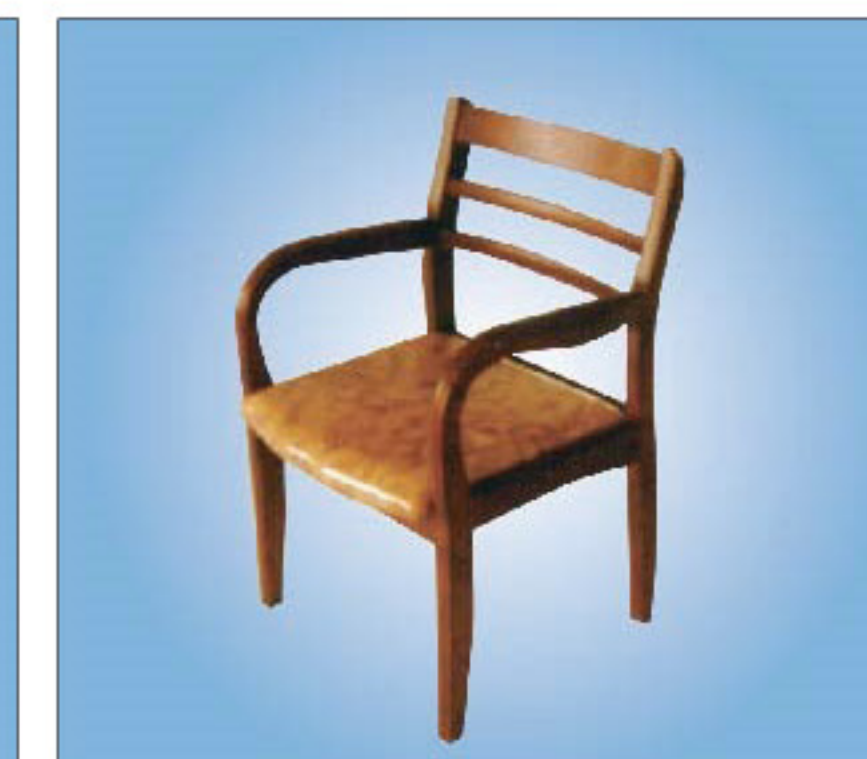

DZYZ-06
扶手椅 B



DZYZ-07
木质引水员椅



DZYZ-08
固定式驾驶椅



DZYZ-09
线控导轨式驾驶椅



布艺色卡

Cloth Color Card



DZ-A01



DZ-A02



DZ-A03



DZ-A04

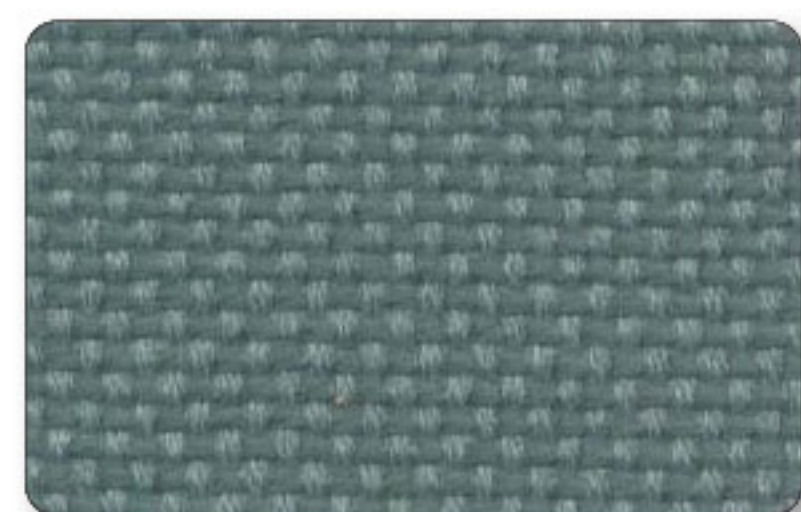

DZ-A05



DZ-A06

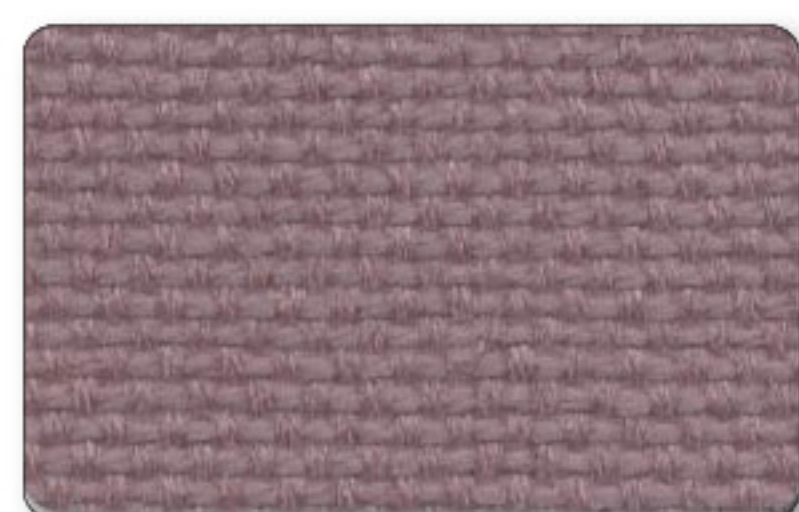

DZ-A07



DZ-A08



DZ-A09

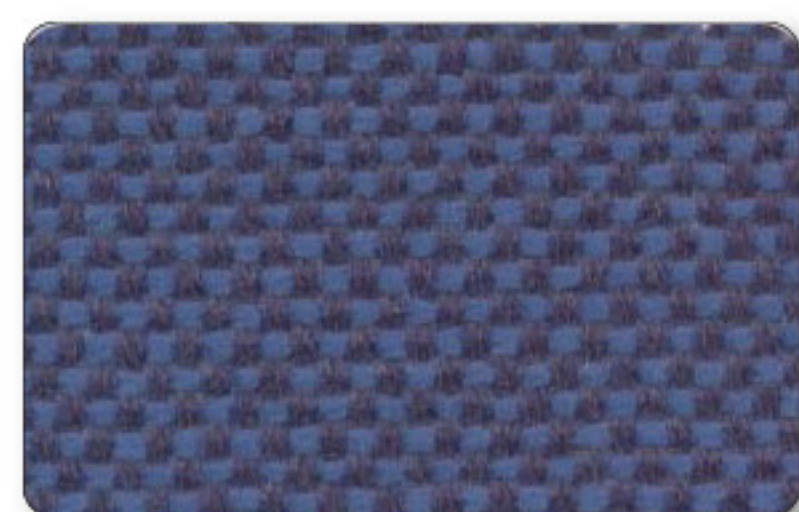

DZ-A10



DZ-A11



DZ-A12



DZ-A13



DZ-A14

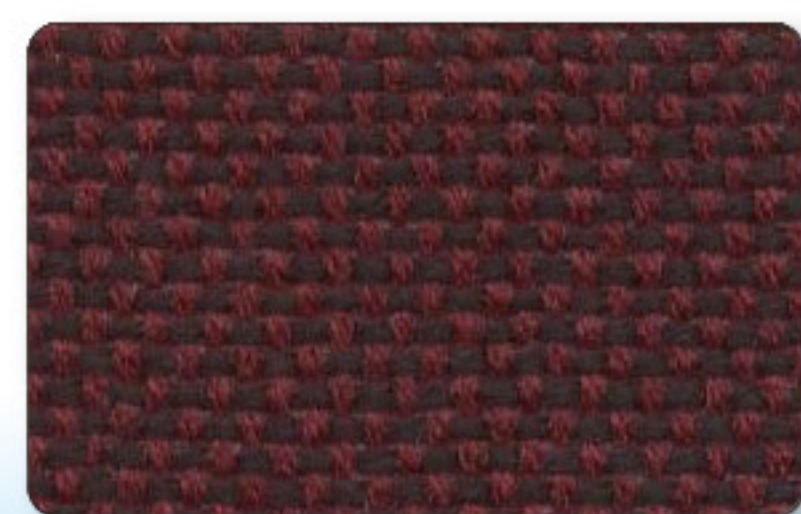

DZ-A15

以上色卡为印刷产物，仅作为真实颜色之参考。The colors reproduced are only an approximate guide to the actual colors obtained in practice.



皮革色卡

Leather Color Card



DZ-B01



DZ-B02



DZ-B03

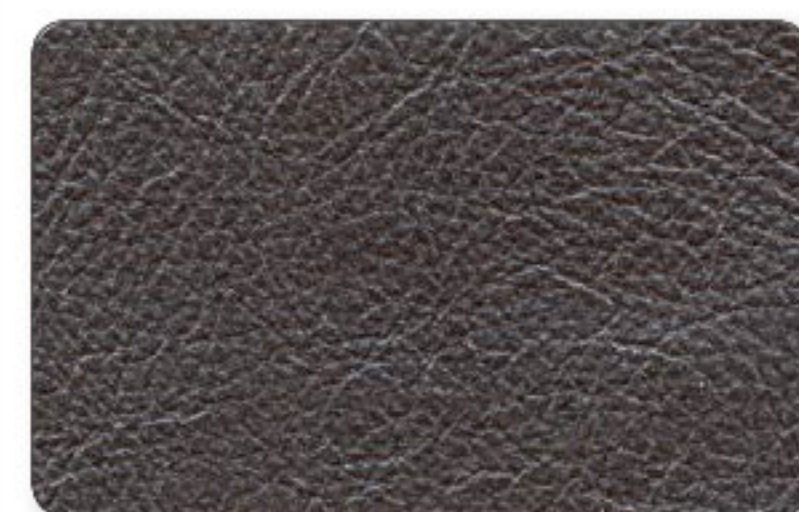

DZ-B04



DZ-B05



DZ-B06

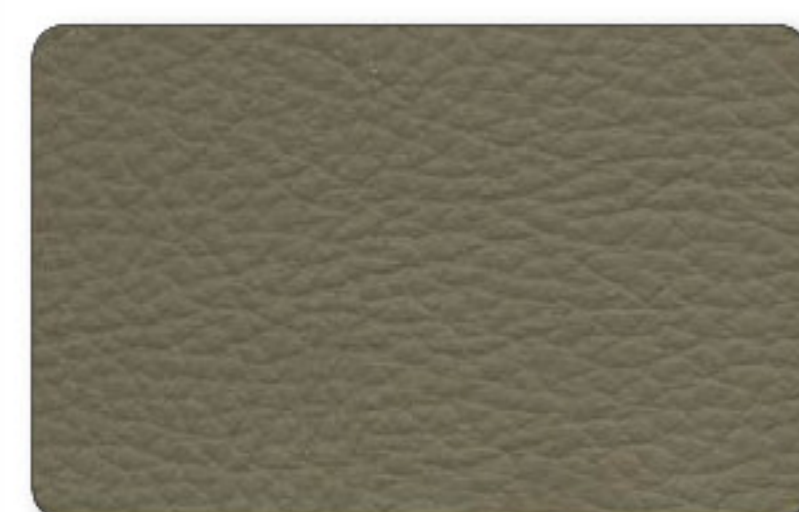

DZ-B07



DZ-B08



DZ-B09



DZ-B10

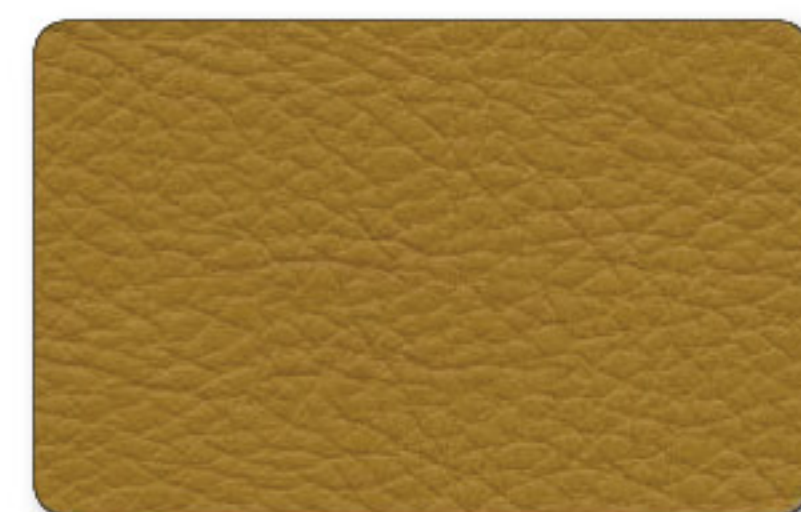

DZ-B11



DZ-B12

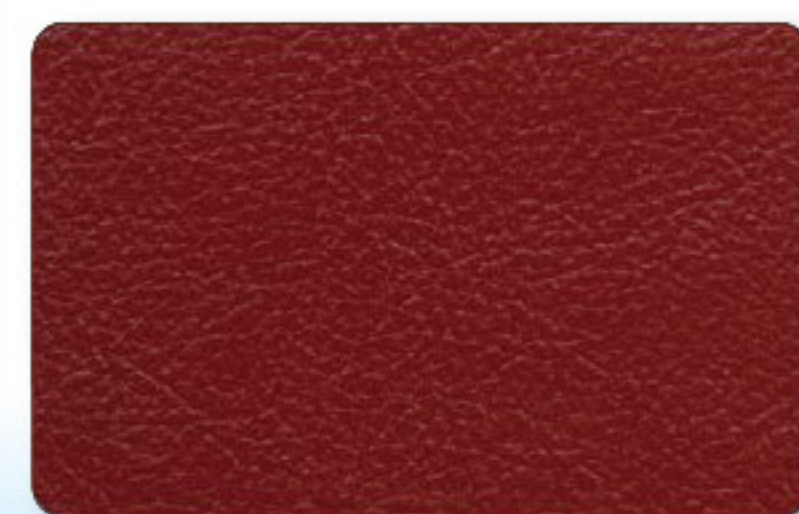

DZ-B13



DZ-B14

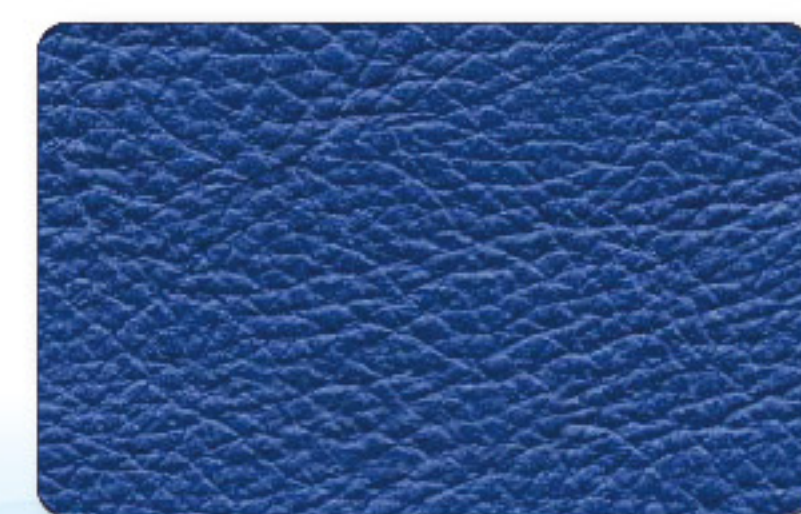

DZ-B15

以上色卡为印刷产物，仅作为真实颜色之参考。The colors reproduced are only an approximate guide to the actual colors obtained in practice.



烤漆色卡

Paint Color Card



以上色卡为印刷产物，仅作为真实颜色之参考。The colors reproduced are only an approximate guide to the actual colors obtained in practice.



PVC 膜色卡

PVC Film Color Card



以上色卡为印刷产物，仅作为真实颜色之参考。The colors reproduced are only an approximate guide to the actual colors obtained in practice.